

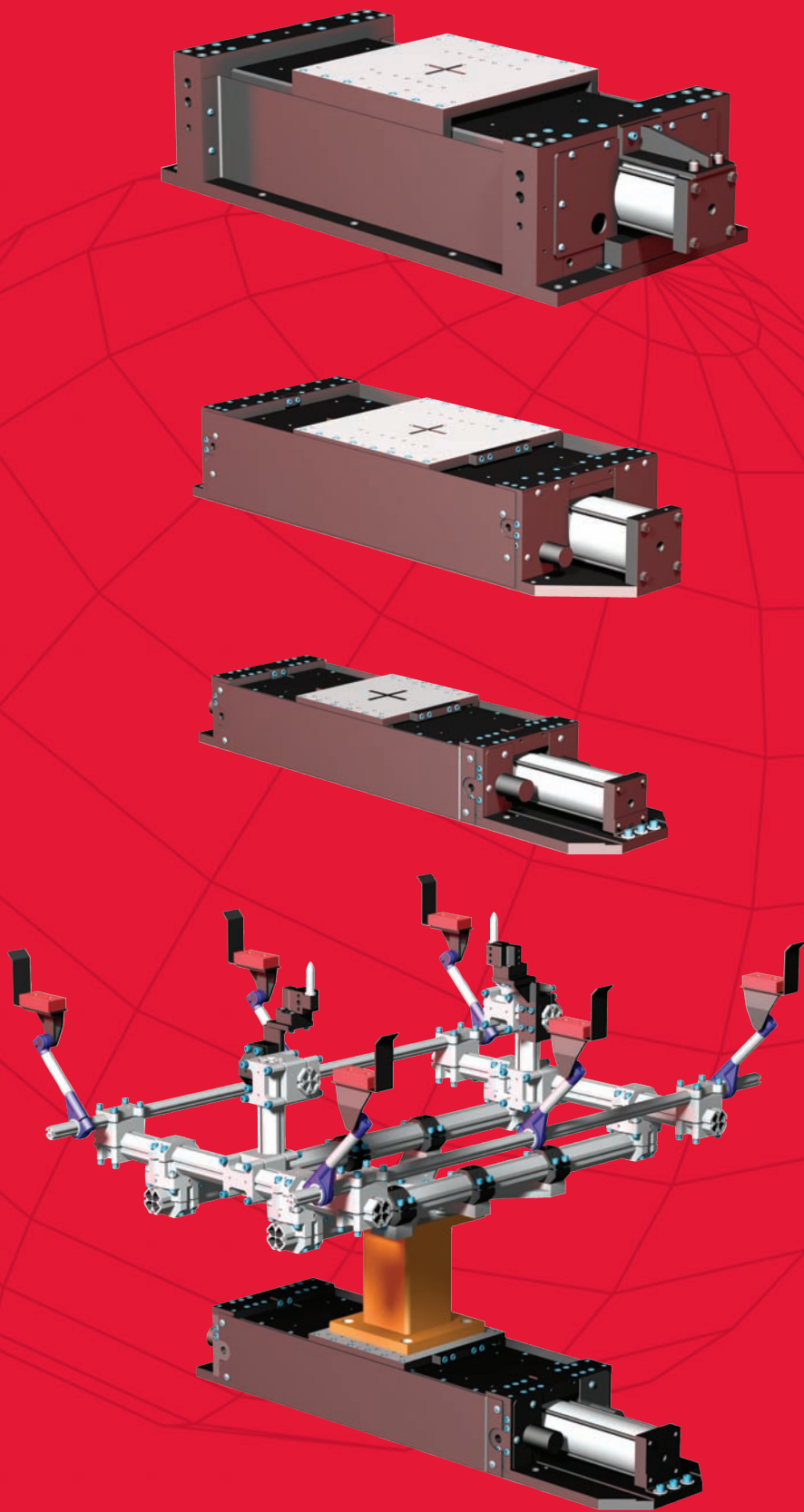

A DOVER COMPANY

# HIGH-CAPACITY PNEUMATIC SLIDES

NOVEMBER 2007



[www.destaco.com](http://www.destaco.com)



CAD FILES  
AVAILABLE  
ONLINE



## WSx Series Pneumatic Slides

### Features and Benefits

#### Steel Structural Frame

- Up To 1350 kg (3000lbs)(WS5)
- Up to 900 kg (2000lbs)(WS4W)
- Up to 454 kg (1000lbs)(WS3W)

#### Guarded

- Sheet metal guards for safety and protection from contamination

#### Manual Lockout System Option

- For safety and maintenance

#### Inverted Design

- **Protects bearing system from weld slag and other contamination**
- **NO flexible bellows or guards required**

*Patents Pending*

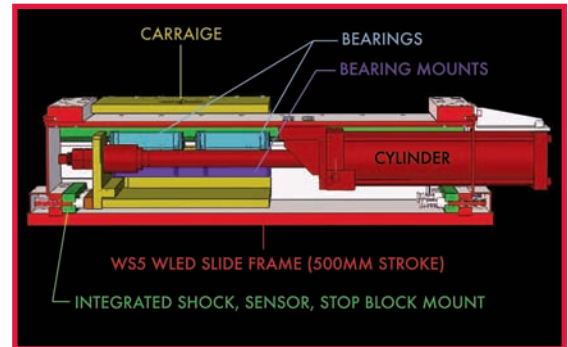

#### Integrated Shock/Sensor/Stop (WS5)

- Reduces field set-up time
- No need to re-set sensor and shocks after shim adjustment
- Uses NAAMS standard shim packages and stops

#### (3) sizes, each with (4) Standard Maximum Strokes of 125 to 500mm

- Index length is easily adjustable in the field
- Provides a common tooling solution
- Pre-Engineered package saves time and money
- Duplex and Rod Lock Options available on all model lengths

## WSx Series Pneumatic Slides Features and Benefits

### “Open Ended” Design

- Allows bearing system replacement **WITHOUT** removing tooling
- Easy to maintain and repair

### Sealed, Self Lubricating Bearing System

- Provides Long Life
- Low Maintenance

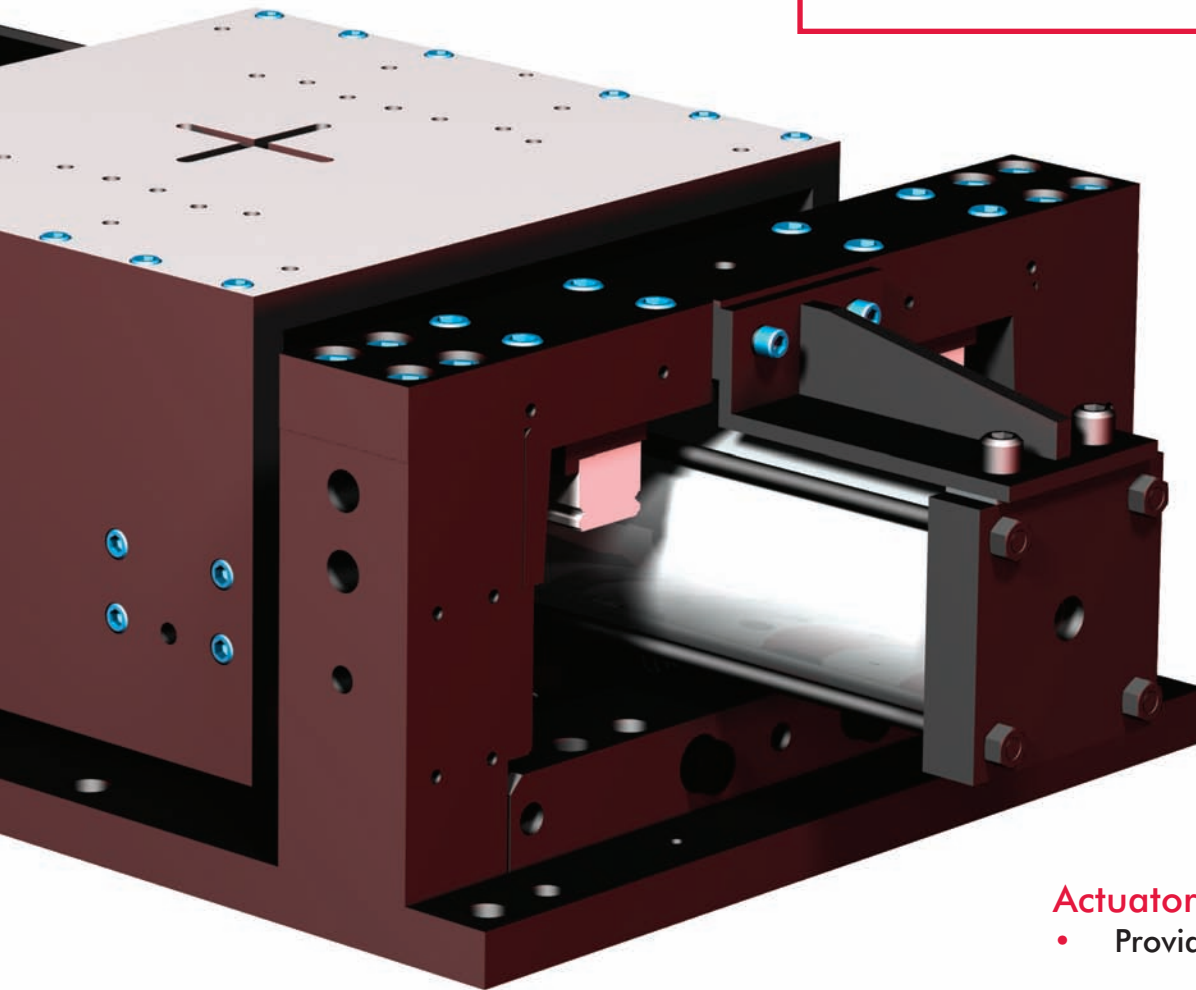
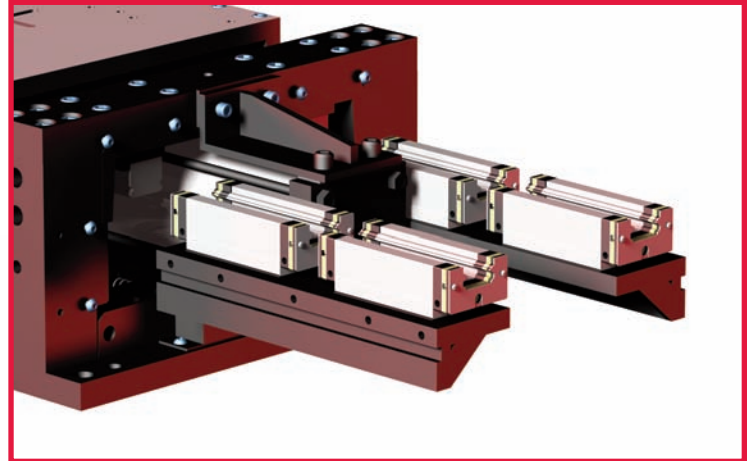

*500mm Weld Slide shown  
without Guards*

### Actuator Mounted Inside

- Provides a compact footprint

### Highly Repeatable

- Repeatable to  $\pm 0.05$  (.002")  
with hard stops

## WSx Series Pneumatic Slides

### Ordering Information

**WS5**

**S**

**500**

**25.0**

#### WELD SLIDE MODEL

**WS3W** = SERIES 3W PNEUMATIC SLIDE

**WS4W** = SERIES 4W PNEUMATIC SLIDE

**WS5** = SERIES 5 PNEUMATIC SLIDE

#### CYLINDER OPTIONS

**S** = STANDARD PNEUMATIC CYLINDER (POINT TO POINT)

**D** = DUPLEXING PNEUMATIC CYLINDER

#### WS4W AND WS5 MODEL

**125** = 125MM MAXIMUM STROKE

**250** = 250MM MAXIMUM STROKE

**375** = 375MM MAXIMUM STROKE

**500** = 500MM MAXIMUM STROKE

#### START POSITION

DISTANCE FROM REFERENCE DATUM TO CENTER DOWEL OF CARRIAGE IN MILLIMETERS(MM)  
(PLEASE SEE PAGE 16 - 17)

#### NOTE

- When using the point-to-point cylinder (Option S), the Home Position, Stroke and Work Position are controlled by lengthening hard stops to suit the application. Standard stroke adjustment increment is 25mm. Please see page 18 for minimum and maximum strokes for each frame size.
- Please contact DE-STA-CO (1-888-DESTACO) for any special features not specifically covered by ordering information or any slide orientation other than horizontal.
- WS Series Slides are NOT designed to be mounted in an inverted position.
- Reference Datum (0.0) is defined by the Dowel Hole in the Frame Base.

## WSx Series Pneumatic Slides Ordering Information

450.0

1

N

### SPECIAL FEATURES

- N = NO POSITION SENSING
- P = PROXIMITY SWITCHS (SPECIFY)
- L = MANUAL LOCKOUT OPTION

### SHOCK ABSORBERS

- 0 = NO SHOCK ABSORBERS
- 1 = SHOCK ABSORBERS REQUIRED  
(ACE MC-4525-4)

### TRAVEL

DISTANCE TO WORK POSITION  
IN MILLIMETERS (MM)  
(PLEASE SEE PAGE 16 - 17)

### ORDERING EXAMPLE

**WS5S500-25.0-450-1N**

### HIGH-CAPACITY PNEUMATIC SLIDE SERIES 5 WITH

- PNEUMATIC POINT-TO-POINT CYLINDER
- 500MM WS5 MODEL
- START POSITION AT 25.0MM FROM REFERENCE DATUM
- 450.0 MM STROKE
- SHOCK ABSORBERS
- NO POSITIONING SENSING

## WS3W Series Pneumatic Slides General Dimensions

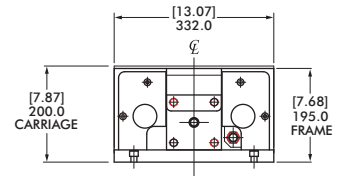
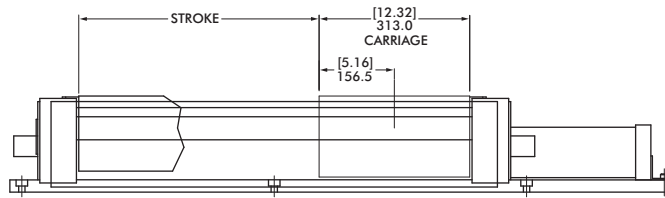
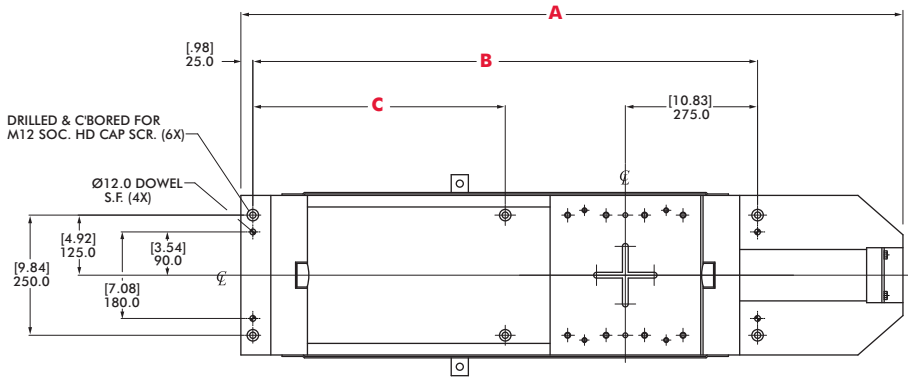
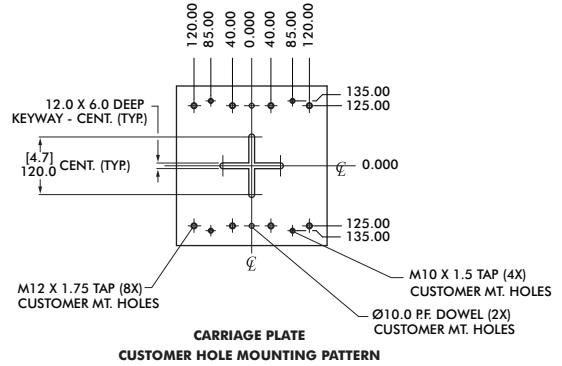
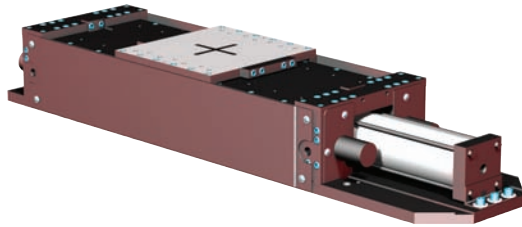

WS4W MODEL	A	B	C	APPROXIMATE WEIGHT
125 mm	725.0	675.0	337.5	156.5 kg [345 lbs]
250 mm	885.0	800.0	400.0	171.0 kg [377 lbs]
375 mm	1135.0	925.0	462.5	189.6 kg [418 lbs]
500 mm	1385.0	1050.0	525.0	209.5 kg [462 lbs]

## WS3 Series Pneumatic Slides Offset vs. Load Charts

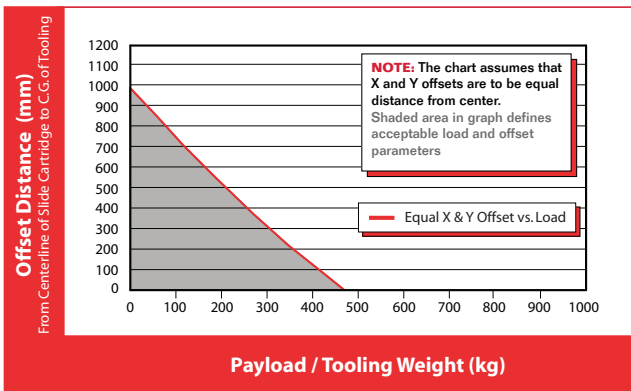
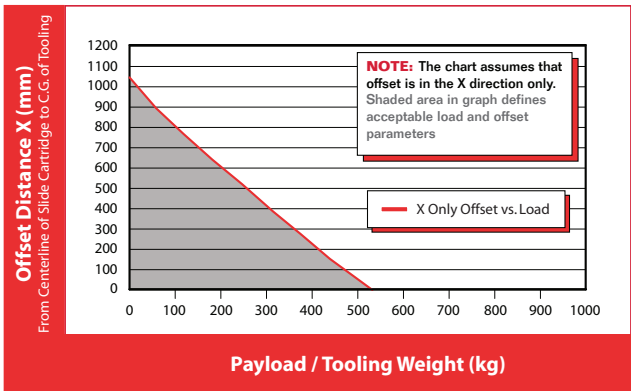
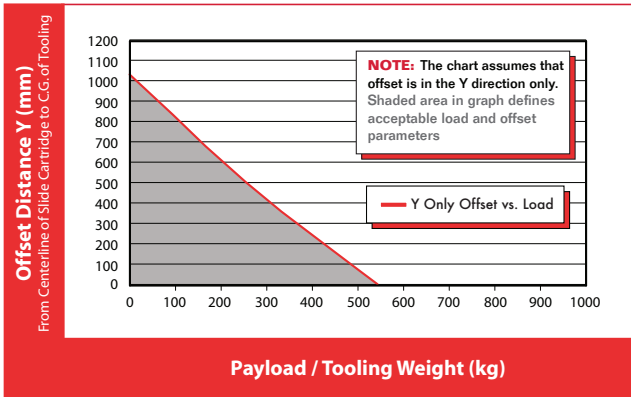

Maximum loads are based on the following parameters:

- Horizontal cylinder velocity = 500 mm/sec [20 in/sec]
- Vertical cylinder velocity = 375 mm/sec [15 in/sec]
- Horizontal acceleration time = 0.2 seconds
- Vertical acceleration time = 0.3 seconds
- Air Pressure = 5.2 bar [75 psi]
- Maximum recommended horizontal, on-center load is 454 kg [1000 lbs.]
- Standard slide cylinder = 100 mm Bore [4.00 in]

## WS4W Series Pneumatic Slides

### General Dimensions

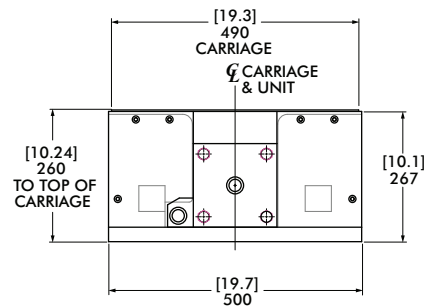
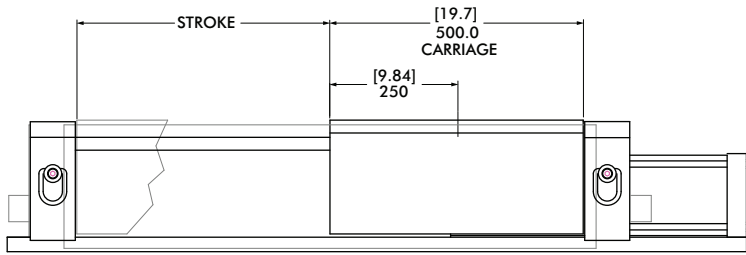
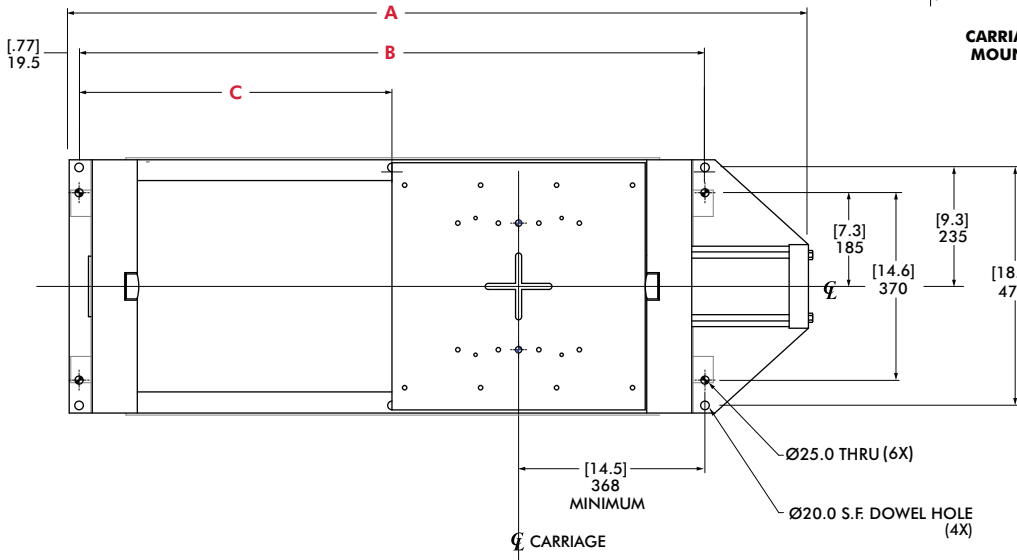
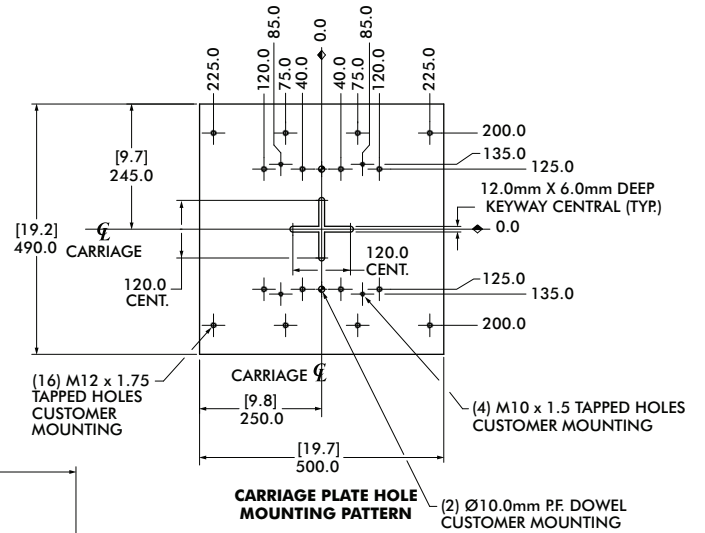
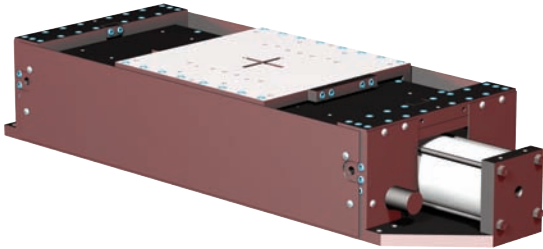

WS4W MODEL	A	B	C	APPROXIMATE WEIGHT
125 mm	900.0	861.0	430.5	489.9 kg [1080 lbs]
250 mm	1025.0	986.0	493.0	522.1 kg [1151 lbs]
375 mm	1223.0	1111.0	555.5	588.3 kg [1297 lbs]
500 mm	1473.0	1236.0	618.0	604.2 kg [1332 lbs]



## WS4 Series Pneumatic Slides Offset vs. Load Charts

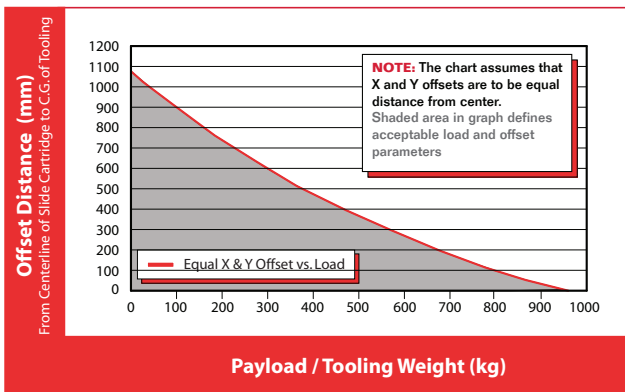
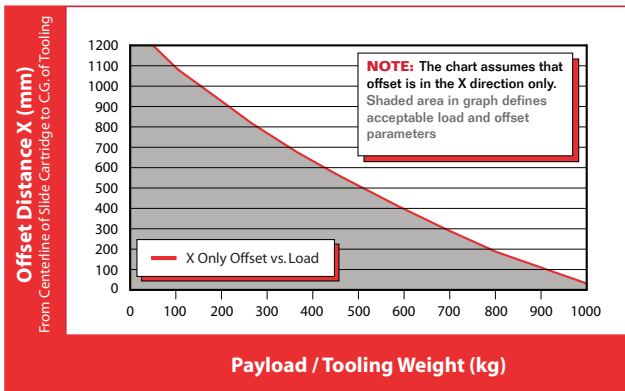
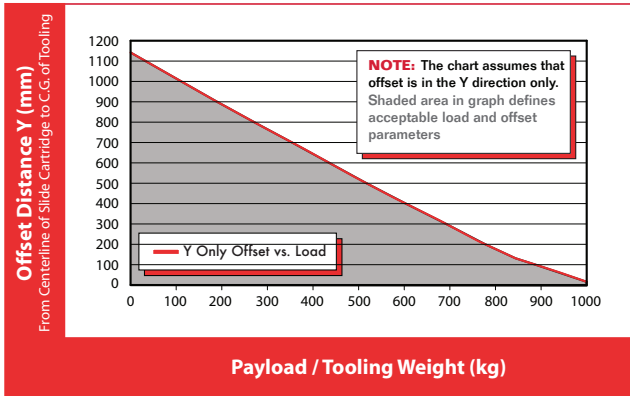

Maximum loads are based on the following parameters:

- Horizontal cylinder velocity = 500mm/second [20 in/sec]
- Vertical cylinder velocity = 375 mm/sec [15 in/sec]
- Horizontal acceleration time = 0.2 seconds
- Vertical acceleration time = 0.3 seconds
- Air Pressure = 5.2 bar [75 psi]
- Maximum recommended horizontal, on-center load is 970 kg [2000 lbs.]
- Standard slide cylinder = 150 mm Bore [6.00 in]

## WS5W Series Pneumatic Slides

### General Dimensions

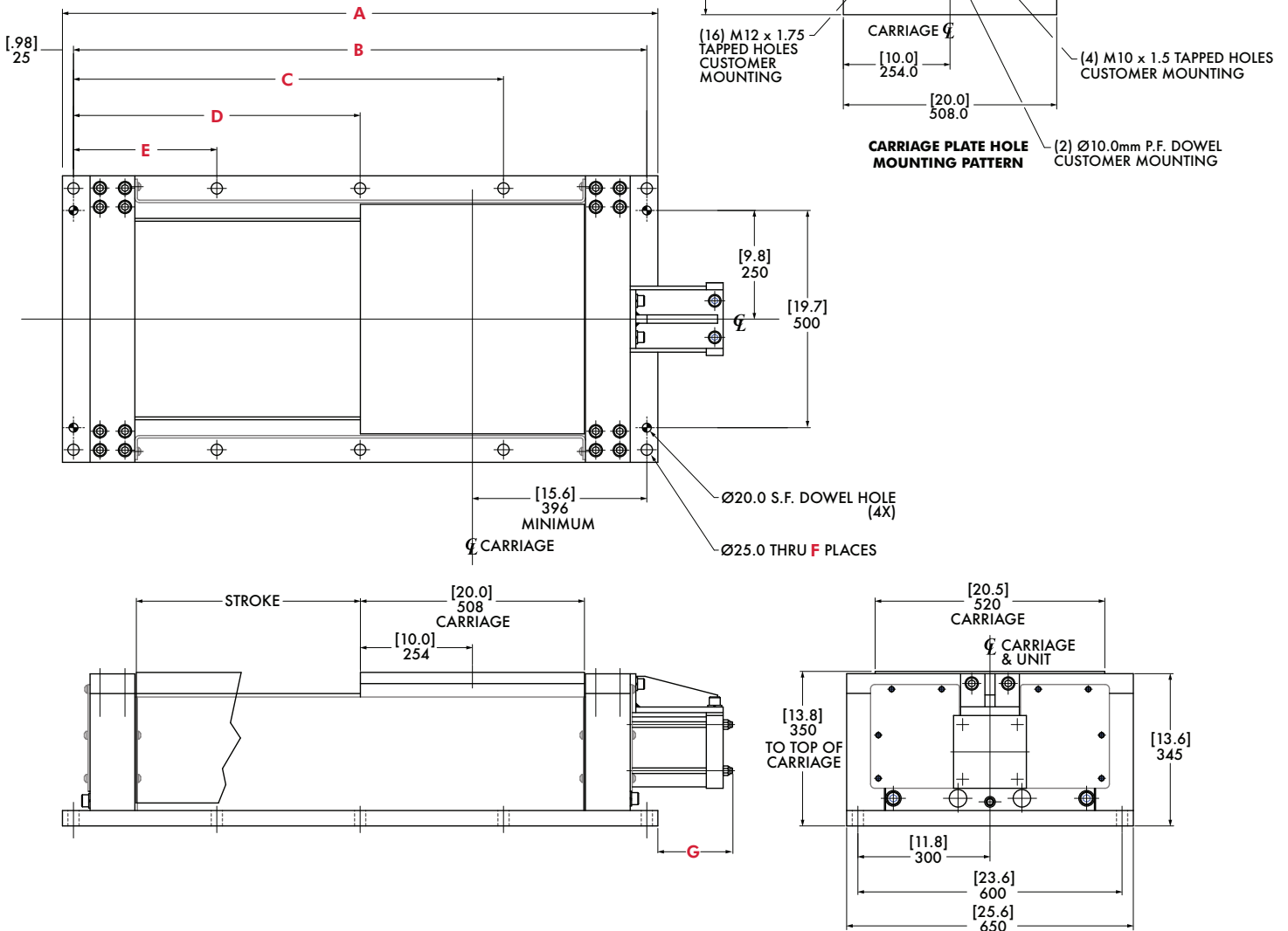
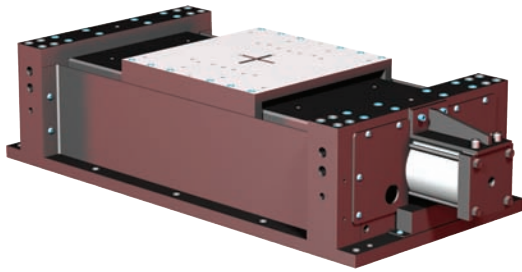

WS5 MODEL	A	B	C	D	E	F	G	APPROXIMATE WEIGHT
125 mm	970.0	920.0	-	460.0	-	6	-	711.2 kg [1568 lbs]
250 mm	1095.0	1045.0	-	522.5	-	6	-	747.5 kg [1637 lbs]
375 mm	1220.0	1170.0	877.5	585.0	292.5	10	41.8	784.3 kg [1729 lbs]
500 mm	1345.0	1295.0	971.3	647.5	323.8	10	167.8	827.4 kg [1824 lbs]

## WS5 Series Pneumatic Slides Offset vs. Load Charts

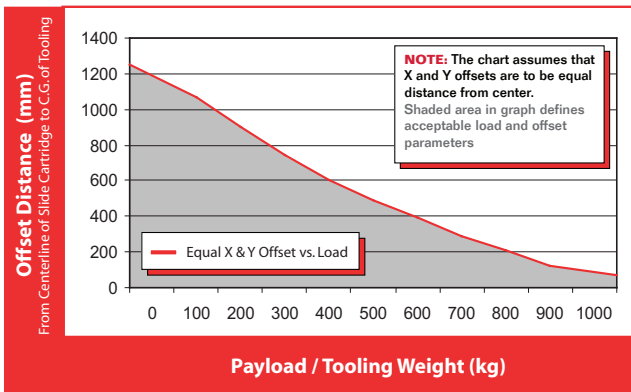
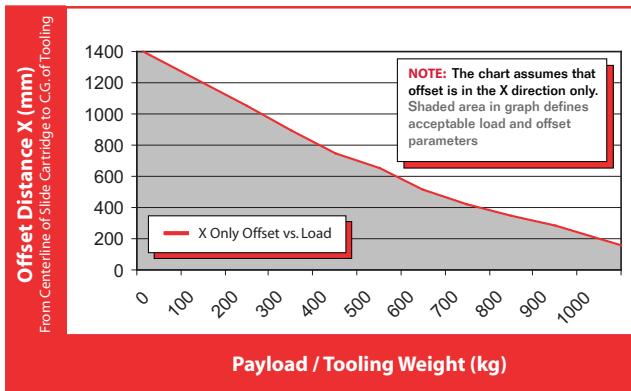
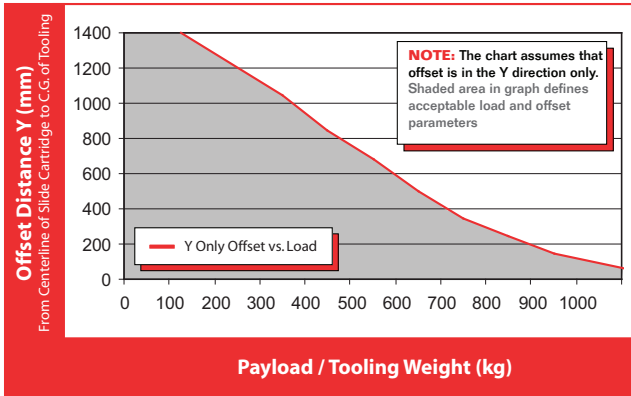

Maximum loads are based on the following parameters:

- Horizontal cylinder velocity = 500 mm/sec [20 in/sec]
- Vertical cylinder velocity = 375 mm/sec [15 in/sec]
- Horizontal acceleration time = 0.2 seconds
- Vertical acceleration time = 0.3 seconds
- Air Pressure = 5.2 bar [75 psi]
- Maximum recommended horizontal, on-center load is 1350 kg [3000 lbs.]
- Standard slide cylinder = 150 mm Bore [6.00 in]

## WSx Series Pneumatic Slides

### Technical Information

#### Maximum Load

MODEL	MAXIMUM LOAD	
	Horizontal Orientation	Vertical Orientation
<b>WS3W</b>	454 kg [1000 lbs]	125 kg [270 lbs]
<b>WS4W</b>	900 kg [2000 lbs]	270 kg [600 lbs]
<b>WS5</b>	1350 kg [3000 lbs]	270 kg [600 lbs]

**Notes:**

Standard slide cylinder is 101.4 mm [4.00 in] bore

Maximum load is based on the following parameters:

- Horizontal cylinder velocity 500 mm/sec [20 in/sec]
- Vertical cylinder velocity is 375 mm/sec [15 in/sec]
- Vertical acceleration time is 0.3 sec

- Air pressure is 5.2 bar [75 psi]

- Load is centered on carriage

#### Point-to-Point Speed

TRAVEL	Speed (in Seconds (sec))	
	Horizontal Orientation	Vertical Orientation
<b>125 mm [4.92 in]</b>	1.2	1.6
<b>250 mm [9.84 in]</b>	1.7	2.2
<b>375 mm [14.76 in]</b>	2.2	2.8
<b>500 mm [19.68 in]</b>	2.7	3.2

**Notes:**

Speed is based on the following parameters:

- $(0.4 \text{ Second Response Time}) \times (\text{Acceleration Time}) \times (\text{Stroke}/\text{Velocity}) = \text{Speed}$
- Response Time = Estimated time for control system and control valve to react and pressurize slide cylinder and initiate motion

#### Stroke Charts

MODEL	Travel		MAX STROKE ADJUSTMENT
	MINIMUM	MAXIMUM	
<b>125 mm [4.92 in]</b>	25 mm [0.98 in]	125 mm [4.92 in]	100 mm [3.97 in]
<b>250 mm [9.84 in]</b>	125 mm [4.92 in]	250 mm [9.84 in]	125 mm [4.92 in]
<b>375 mm [14.76 in]</b>	250 mm [9.84 in]	375 mm [14.76 in]	125 mm [4.92 in]
<b>500 mm [19.68 in]</b>	375 mm [14.76 in]	500 mm [19.68 in]	125 mm [4.92 in]

**Notes:**

- A slide set-up for maximum stroke is *not* supplied with stroke adjusters
- Stroke adjusters are varying length's and may be used on either or both sides of carriage.
- Maximum stroke adjuster length in any combination is 125.0 mm. Maximum stroke adjuster length for 125 mm stroke unit is 100 mm.
- When using a slide at or near maximum travel, review the application thoroughly to determine if the next size larger frame should be specified to accommodate process adjustments.

## WSx Series Pneumatic Slides Maximum Load Versus Angle of Incline

INCLINE ANGLE (°)	MAXIMUM LOAD		
	WS3W Series	WS4W Series	WS5 Series
<b>0° (Horizontal)</b>	454 kg [1000 lbs]	907 kg [2000 lbs]	1350 kg [3000 lbs]
<b>5°</b>	435 kg [965 lbs]	865 kg [1910 lbs]	1300 kg [2870 lbs]
<b>10°</b>	415 kg [920 lbs]	840 kg [1850 lbs]	1140 kg [2516 lbs]
<b>15°</b>	395 kg [875 lbs]	650 kg [1430 lbs]	1030 kg [2284 lbs]
<b>20°</b>	380 kg [840 lbs]	570 kg [1250 lbs]	790 kg [1735 lbs]
<b>25°</b>	365 kg [800 lbs]	465 kg [1025 lbs]	640 kg [1408 lbs]
<b>30°</b>	345 kg [765 lbs]	450 kg [990 lbs]	540 kg [1192 lbs]
<b>35°</b>	330 kg [725 lbs]	420 kg [925 lbs]	470 kg [1040 lbs]
<b>40°</b>	305 kg [675 lbs]	385 kg [850 lbs]	420 kg [929 lbs]
<b>45°</b>	209 kg [640 lbs]	355 kg [785 lbs]	380 kg [845 lbs]
<b>50°</b>	260 kg [575 lbs]	335 kg [740 lbs]	350 kg [781 lbs]
<b>55°</b>	235 kg [520 lbs]	315 kg [695 lbs]	330 kg [730 lbs]
<b>60°</b>	205 kg [460 lbs]	300 kg [660 lbs]	310 kg [681 lbs]
<b>65°</b>	180 kg [395 lbs]	295 kg [645 lbs]	300 kg [661 lbs]
<b>70°</b>	160 kg [350 lbs]	285 kg [630 lbs]	290 kg [638 lbs]
<b>75°</b>	140 kg [310 lbs]	280 kg [615 lbs]	280 kg [615 lbs]
<b>80°</b>	132 kg [290 lbs]	275 kg [608 lbs]	275 kg [608 lbs]
<b>85°</b>	126 kg [278 lbs]	270 kg [602 lbs]	270 kg [602 lbs]
<b>90° (Vertical)</b>	125 kg [270 lbs]	270 kg [600 lbs]	270 kg [600 lbs]

**Notes:**

These weights are in addition to carriage plate and bearing assemblies. Loads are centered on the carriage plate.

Standard slide cylinder is; 150.0 mm [6.00 in] bore for WS4W and WS5, 101.4mm [4.00 in] bore for WS3W.

Maximum load is based on the following parameters:

- Horizontal cylinder velocity 500 mm/sec [20 in/sec]
- Vertical cylinder velocity is 375 mm/sec [15 in/sec]
- Vertical acceleration time is 0.3 sec
- Air pressure is 5.2 bar [75 psi]
- For maximum recommendation load, please see chart on page 18.

## WSx Series Pneumatic Slides

### Repeatability Chart

CYLINDER TYPE	SLIDE VELOCITY			
	50 mm/sec [2 in/sec]	100 mm/sec [4 in/sec]	300 mm/sec [12 in/sec]	500 mm/sec [20 in/sec]
Standard Point-to-Point with hard stops at each end	+/- .05 mm	+/- .05 mm	+/- .05 mm	+/- .05 mm

### Accuracy versus Repeatability

To understand slide performance and application, it is necessary to differentiate between accuracy, repeatability and resolution. Since these terms can often be used incorrectly as they are thought to be interchangeable, we will attempt to define some of the terminology:

#### Slide

A single axis positioning system, generally having an index length of one meter or less

#### Tooling

Any device which operates within the confines of a given tool or cell, for the purpose of positioning parts or equipment (weld guns, clamps, etc.)

#### Absolute Precision

The theoretically correct position.

#### Accuracy

The difference between the absolute position and the mean of a series of repetitive measures.

#### Repeatability

The degree to which a series of repetitive measurements on a single system agree with one another.

#### Resolution

The smallest achievable or detectable change in position.

### Guidelines for Slide Requirements:

Determine which of the following is required:

**Accuracy** – If the slide must move *to an exact length or absolute position*, the applications requires accuracy, repeatability and high resolution.

**Repeatability** – If the slide must move *to the same location, time after time*, the application requires only repeatability.

**Resolution** – If the slide must move *until it is stopped by a position sensor or mechanical stop*, the application requires neither accuracy nor precision.

In general, in most applications, repeatability will be important than accuracy. Be aware that load, speed and the type of actuator driving the slide affects repeatability.

## Also Available

# The SLA Series of programmable servo slides is one of the first in the industry to utilize **Smart Motor Technology**

- Drive is located on the actuator – no external controller required in most cases
- Smart linear actuators are controlled by only 6 conductors – resulting in a lighter cable bundle for improved life cycle
- Motor drive is built onto the motor which, in many cases, eliminates the need for an external controller – reducing the amount of space required in a control cabinet
- Ball screw is integrated to the motor – no coupling
- An external computer is not required for simple 2-3 axis synchronized motion. Saves cost and control cabinet space
- 48V DC brushless servo motor
- T-Slot for toe clamp

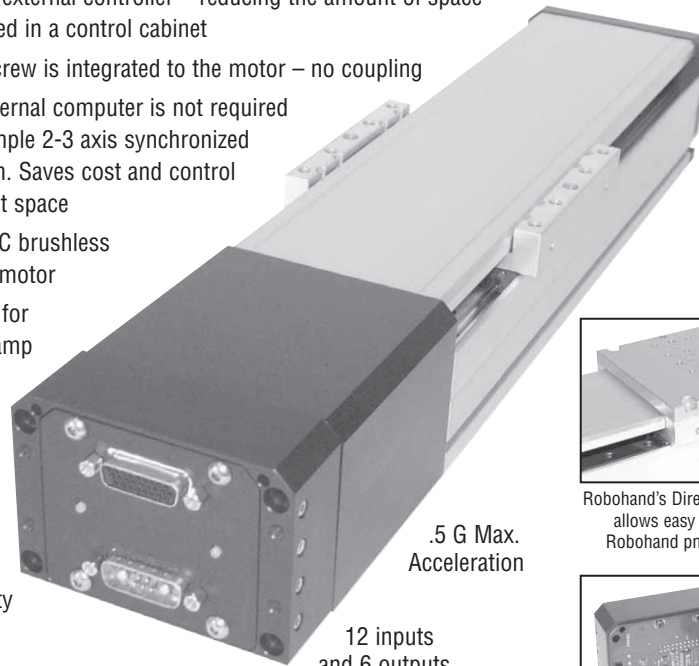

± .02mm  
(.0008")  
repeatability

.5 G Max.  
Acceleration

12 inputs  
and 6 outputs

Model	Rated Thrust (N[lbf])
SLA-90	150 [33.72]
SLA-120	165 [37.09]
SLA-150	330 [74.19]

**Weld field immune electronics and weld spark resistant cover available on all sizes.**

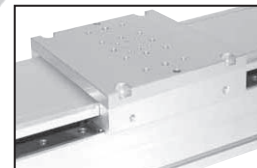

Robohand's DirectConnect pattern allows easy integration of Robohand pneumatic slides

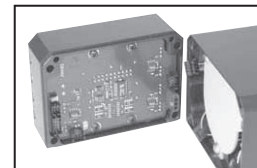

Smart Motor – Integral drive and motor built-in for space savings and, in many cases, the elimination of an external controller

Contact  
**DE-STA-CO**  
for more information

## A TRUE GLOBAL PRESENCE

Through a constant commitment to the Team DE-STA-CO philosophy, we draw from our worldwide pool of information and resources to offer the highest levels of service to each of our customers, regardless of geographic location. Our status as a truly global company empowers us to improve the global competitiveness of your operations. Whatever your automation or workholding need, Team DE-STA-CO has the best possible solution.



## ABOUT DE-STA-CO

DE-STA-CO, a Dover Company, was founded in 1915. In 1936 the company designed and manufactured the first manual toggle clamp.

Innovations, quality and acquisitions have made DE-STA-CO the worldwide leader in the design, manufacture and support of clamping, gripping, transferring and robotic tooling solutions for workplace and flexible automation needs.

The family of brands has enabled DE-STA-CO to establish leading productivity improvement and cost-reduction manufacturing solutions for our customers using the breadth of products and value-added services we offer.

Our customer base covers a wide range of industries requiring a global customer service network offering consistent solutions and program support. With over 85 years of experience, DE-STA-CO brings a quality philosophy unsurpassed by its counterparts.

## DE-STA-CO LEAN INITIATIVE

The DE-STA-CO family of companies is committed to being a lean resource for its customers, providing ways to eliminate waste in manufacturing processes through the use of optimal clamping and automation solutions that eliminate bottlenecks.

DE-STA-CO's wide range of products allows the company to offer its customers an Automation Continuum™ providing solutions that increase profitability and efficiency, while reducing waste.

### PRODUCT WARRANTY

All DE-STA-CO Products are thoroughly inspected and tested. We fully guarantee all materials and workmanship to be free of defects. Any product that is found to be defective in design, material or workmanship in the course of its normal use will be promptly replaced.

This Warranty does not apply to any product where the failure is a result of misapplication or abuse, nor is there any Warranty expressed or implied as to the merchantability or fitness for a particular purpose of the product and any warranty is limited to the above express warranty.

This Warranty is null and void if the product is repaired, modified or altered in any way.

DE-STA-CO is not liable for labor, special, direct, incidental, or consequential damages and under no circumstances any charges in excess of the invoice amount of the product proven to be defective.



A DOVER COMPANY

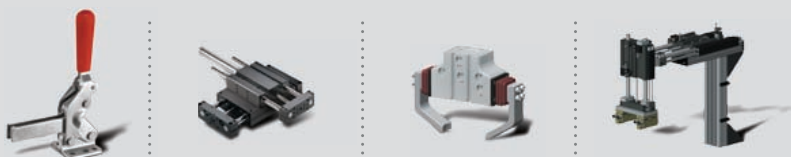

Positioning our customers for productivity.

© Copyright, 2007 DE-STA-CO.

All rights with regards to logos, layout, photos and text, including all artwork, rest with DE-STA-CO.

All photomechanical or other reproductions can only be made with our expressed permission.

47495 Clipper Street  
Plymouth, MI 48170  
Phone: 888-DE-STA-CO  
Fax: (734) 454-1536  
Customer Service E-mail:  
cs-automotive@destaco.com  
Techical Support E-mail:  
tech-automotive@destaco.com  
[www.destaco.com](http://www.destaco.com)