

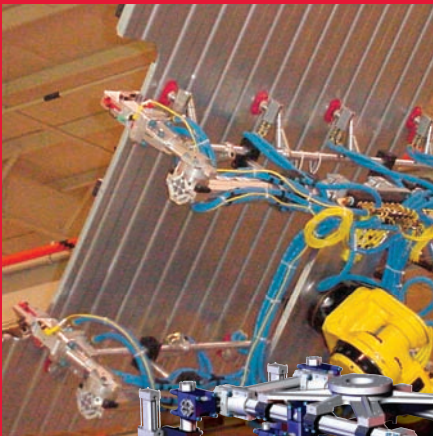

WORKHOLDING & AUTOMATION SOLUTIONS

Transportation Manufacturing Industry



Custom Products

Vertical Clamps

Horizontal Clamps

Squeeze Action Plier Clamps

Hydraulic Clamps

Straight-Line Action Clamps

Variable Stroke Straight-Line Action Clamps

Latch Clamps

Pneumatic Clamps

<<End Effector Tooling

Toolchangers

Rotary Actuators

Grippers

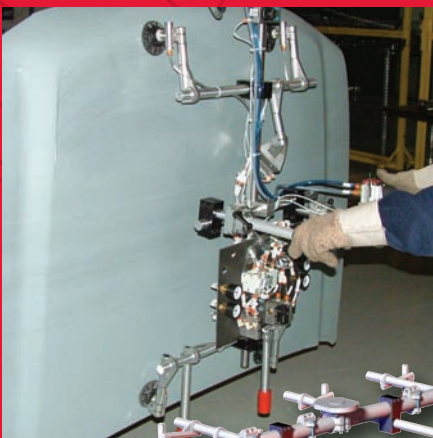
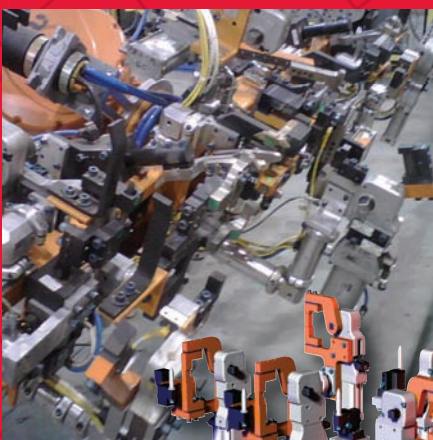



Solutions that can drive your productivity in the right direction.

A MANUFACTURER MUST BE PREPARED TO OFFER COMPLETE SOLUTIONS AS WELL AS OPERATE IN A GLOBAL MARKET. DE-STA-CO'S COMMITMENT TO PROVIDING INDUSTRY-LEADING PRODUCTS, SERVICE AND SUPPORT ENCOMPASSES THE WHOLE OF THE WORLD IN WHICH YOU DO BUSINESS.

DE-STA-CO understands the need to provide the transportation manufacturers with quality products, services and support, as well as flexible, customized solutions to fit their particular application.

We harness the whole of our resources to ensure we offer a complete one-stop-shop solutions worldwide. In every country that you conduct business, we provide and support the same standard-setting array of workholding and automation components as well as end-effector solutions. The longevity and performance of our products results in the lowest cost of ownership in the industry. Wherever your operations are located, the unmatched quality and value of DE-STA-CO are available.



MORE THAN PRODUCTS. COMPLETE SOLUTIONS.

EXTENSIVE CAD CAPABILITIES

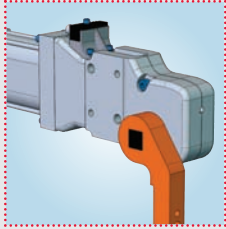

To ensure applicability to the broadest possible base of aerospace manufacturers, DE-STA-CO supports a wide variety of CAD programs, ranging from Catia to Unigraphics. All CAD formats are accessible through multiple channels, including our cutting-edge online digital catalog, located at www.destaco.com. This web-based 3D CAD library allows engineers to configure individual 3D models from DE-STA-CO's extensive array of workholding and automation products. The intuitive system is part of DE-STA-CO's commitment to providing the exact CAD information you need, whenever you need it.

WWW.DESTACO.COM

Our global website is a constant resource for our customers worldwide. Designed to be a one-stop engineering resource center, our website was developed by engineers for engineers. Presented in multiple languages, www.destaco.com provides detailed comprehensive product information, data sheets and CAD information twenty-four hours a day, seven days a week.



OUR GLOBAL WEBSITE ALSO OFFERS:

- Access to local sales representatives and dealers
- Expert application advice
- Sizing software
- Training information
- Customer service access
- Downloadable literature

TECHNICAL EXPERTISE, SERVICE AND SUPPORT

At DE-STA-CO, we maintain the highest possible standards of service and support across all of our product offerings. Our employees possess extensive engineering knowledge and receive comprehensive training on all of our products. When you partner with DE-STA-CO, you work with specialists that fully understand your operations, our products and how the two work together to provide you with value. Our customer service staff is available via a toll-free phone line, fax, email and our company website, so that you can reach us through whatever medium is most convenient.



COMPLETE PRODUCT HANDLING AND APPLICATION SOLUTIONS...

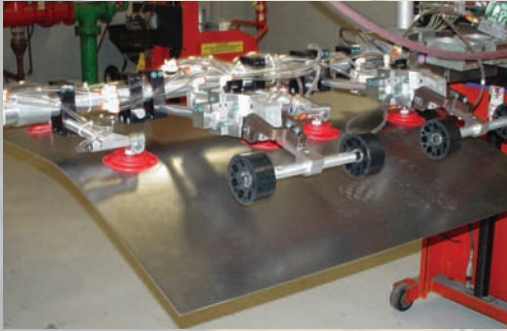

Round Tooling with Vacuum Cups and Rollers

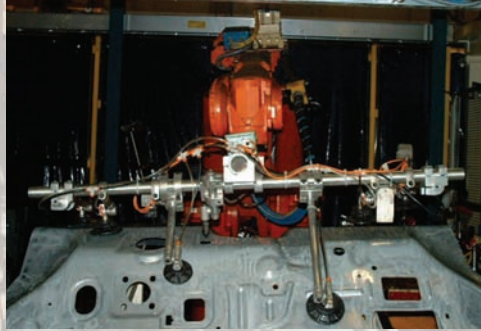

Round Tooling with Vacuum Cups

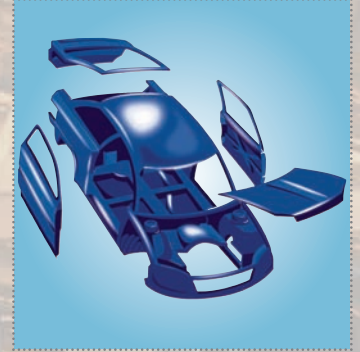

METAL STAMPING

BodyBuilder™ and round tooling end effectors, vacuum products and magnets.

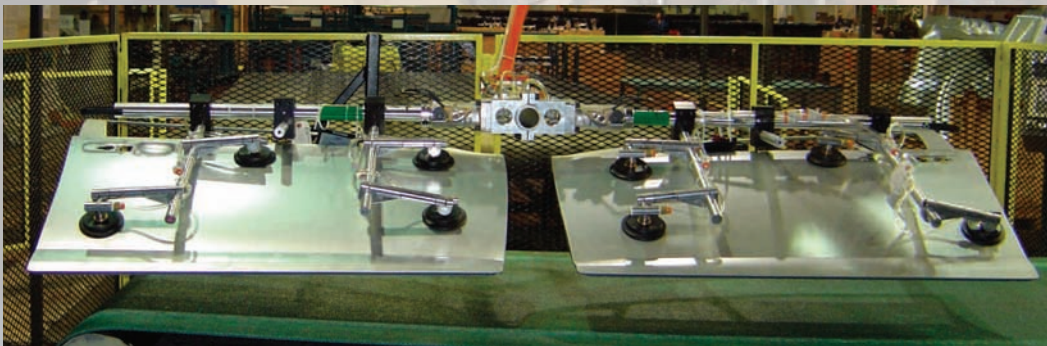

WorldTool End Effector with Vacuum Cups



Automotive Power Clamps

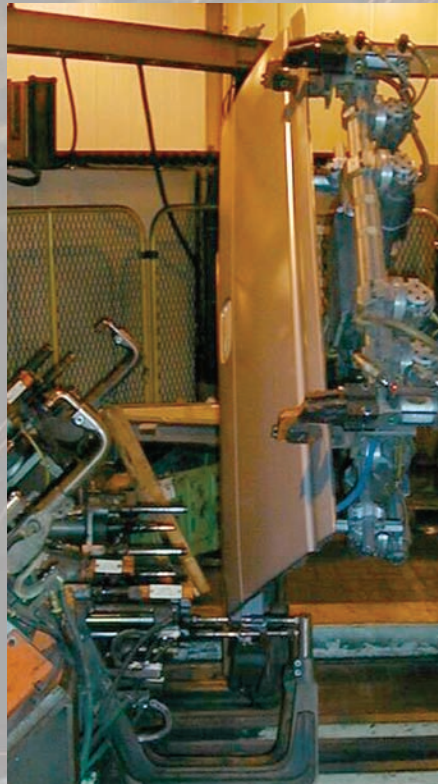

BodyBuilder™ End Effectors

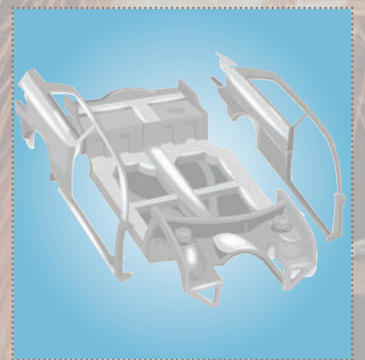

BODY ASSEMBLY AND WELDING

BodyBuilder™, SpiderGrip and round tooling end effectors, clamps and grippers.

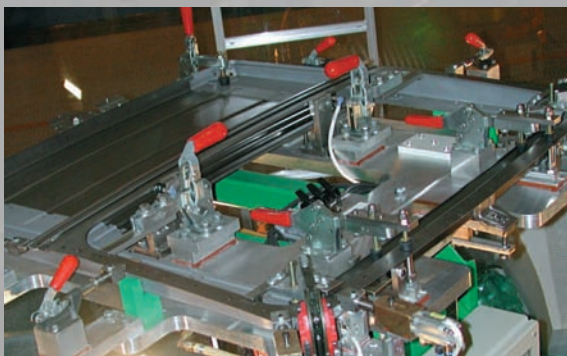

Vertical and Plunger Manual Clamps

... FOR EVERY STAGE OF MANUFACTURING IN THE TRANSPORTATION INDUSTRY

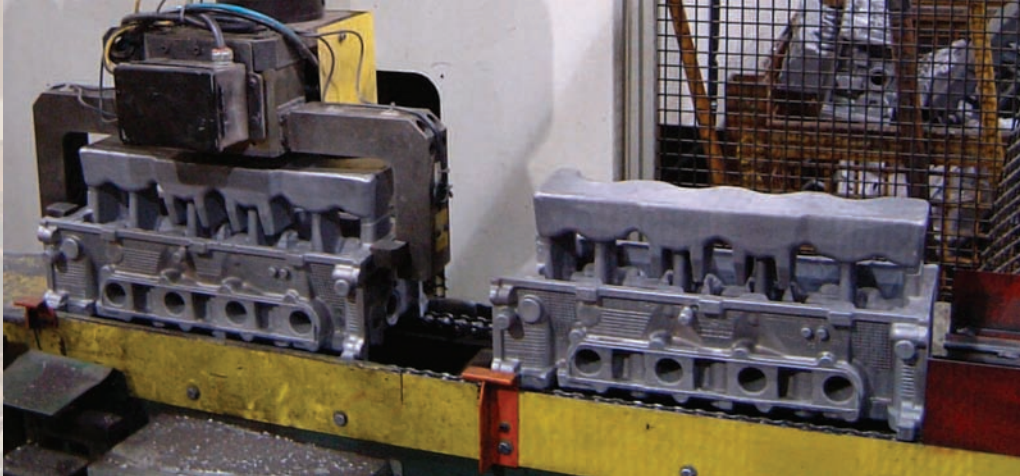

Engine Block Handling with a RP Series Double Wedge Parallel Gripper.



POWERTRAIN

Parallel and Angular Grippers, Tool Changers, and Slides.

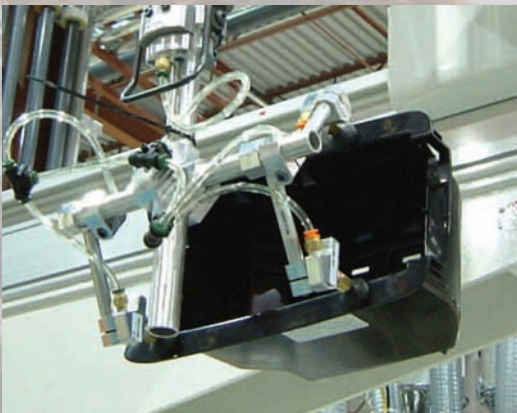

Plastics Handling with Round Tooling

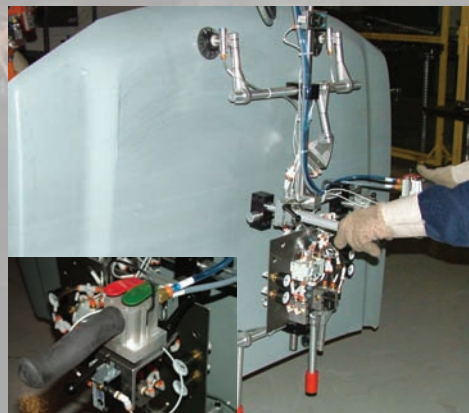

Manual Assest with Round Tooling

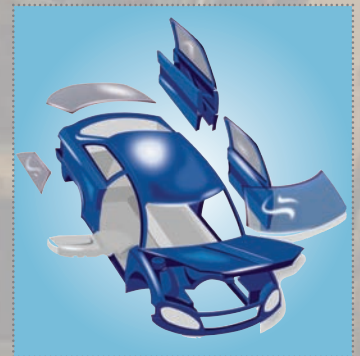

FINAL ASSEMBLY, TRIM, GLASS HANDLING AND PLASTIC INJECTION MOLDING

Round Tooling, Vacuum Products, Grippers, Sprue Grippers and Cutters.

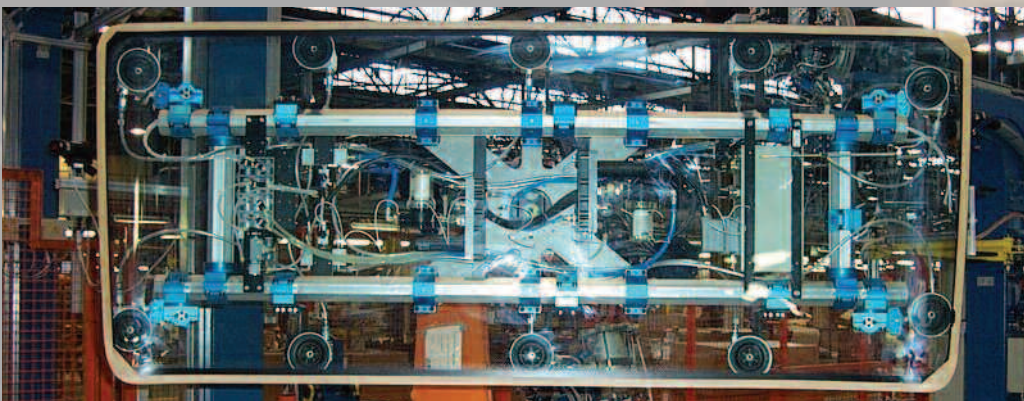

Glass Handling with BodyBuilder™ and Vacuum Cups

CUSTOMIZED SPECIAL PRODUCTS

EACH OF YOUR APPLICATIONS IS UNIQUE and sometimes it takes more than a standard product to achieve maximum performance in transportation manufacturing. When such an occasion arises, DE-STA-CO's special engineering services department will work extensively to meet that need by modifying an existing product or creating an entirely new component. Throughout this process, you will work with a highly trained engineer who understands your specific needs. Once a special product is created, it is assigned a part number and entered into our system. This guarantees a quick response to future orders, even if you are the only company in the world that is using that specific product.

••• BEST SOLUTIONS.

••• UNIQUE PART NUMBERS.

••• EXPERT SUPPORT.



High temperature pneumatic clamp for airframe manufacturing.



Pneumatic clamp with manual actuation handle.



Plier clamp modified for mounting plate.



Stainless steel clamp with special hook and locking tab.

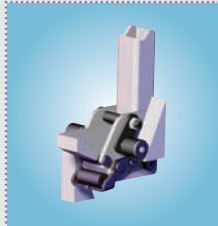

Manual Door Carrier Clamp

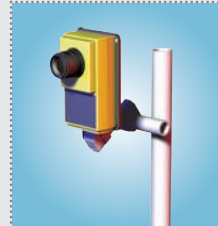

Specialty tooling and engineering systems

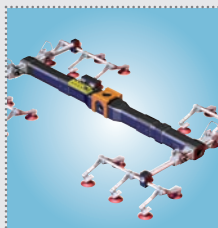

Carbon fiber end effector tooling.

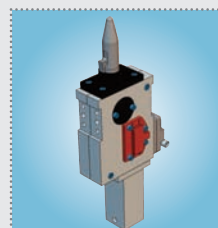

Locate and clamp sheet metal in welding and material transfer applications.



POWER CLAMPS AND PIN CLAMPS FOR THE TRANSPORTATION INDUSTRY

AUTOMATION POWER CLAMPS

- Automation power clamps are designed for requirements of the automotive and sheet metal processing industries.
- They are the perfect choice when it comes to clamping, holding and positioning metal sheets and other components on and in a fixture.
- Enclosed versions are particularly well suited to welding systems.
- Sensors are available to monitor arm position. This optional feature is a distinct advantage in automatic production systems. All clamps share one common feature; they are designed to last millions of cycles if the application complies with guidelines.



82L SERIES CLAMPS



82M SERIES CLAMPS

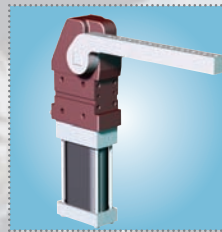

82G SERIES CLAMPS

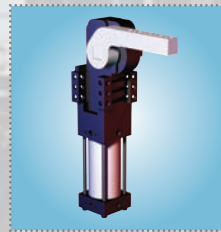

ROUND BORE CLAMPS



Power Clamps are used for materials handling and welding applications.

PNEUMATIC PIN CLAMPS

- 82P series pneumatic pin clamps are designed to locate and clamp sheet metal in welding and material transfer applications.
- 52 series manual pin clamps are designed for prototype build, short run production, and CMM manual pallet systems.
- 86P series locating pin clamps is used to position and center sheets in fixtures and handling systems, and features a retractable pin, and integrated wiper ring to remove weld spatter on piston rod.
- All series features a fully enclosed body to protect mechanism from contaminants in welding applications. Hardened tool steel pins have full 360° Geometric sheet metal contact with a closed off design when clamped and when unclamped to prevent contamination from entering the unit.



82P SERIES PNEUMATIC PIN CLAMPS

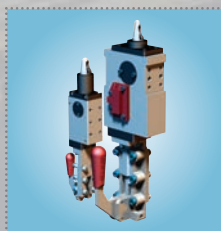

52F SERIES MANUAL PIN CLAMPS

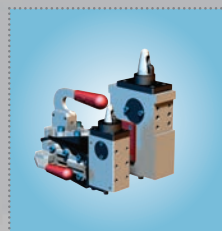

52R SERIES MANUAL PIN CLAMPS



86P SERIES LOCATING PIN CLAMPS

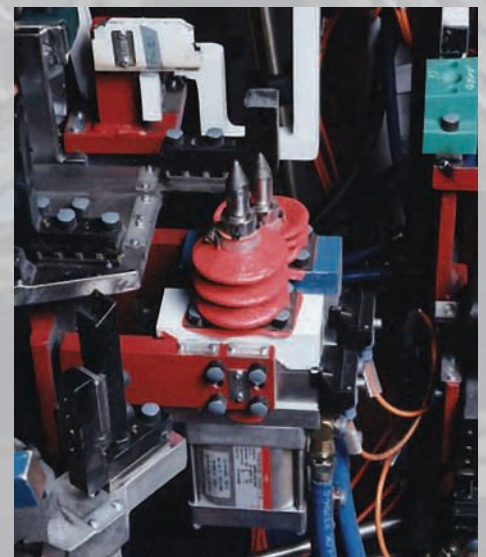

The **86P Series Pin Clamp** has a centering pin seat in a precision bore or in a thread. The piston rod is secured from rotation.

END EFFECTOR SOLUTIONS FOR THE TRANSPORTATION INDUSTRY

CUSTOMIZED MATERIAL HANDLING SOLUTIONS

- **Bodybuilder™ Robotic End Effector System** features octagonal booms and clamp mounts designed to be stiff under the twisting, bending moments of a robot's motion. The patented alignment system allows modular components to be replaced individually and easily returned to their original positions.
- **SpiderGrip™ Modular Geometric End Effector System** components are made of high grade aircraft quality aluminum. This tooling system offers high strength-to-weight ratios and maintains dimensional accuracy when replacing individual components.
- **Carbon Fiber World Tool** is a high-strength, lightweight tooling solution designed to dramatically increase overall performance in production while decreasing vibration. Internal steel mounting plates ensure solid connection between boom and automation.
- **Round Tooling Systems** are ideal for small part handling, and unusually shaped objects. This tooling system is constructed of lightweight aluminum and offers a high-volume, low-cost, fully customizable solution.

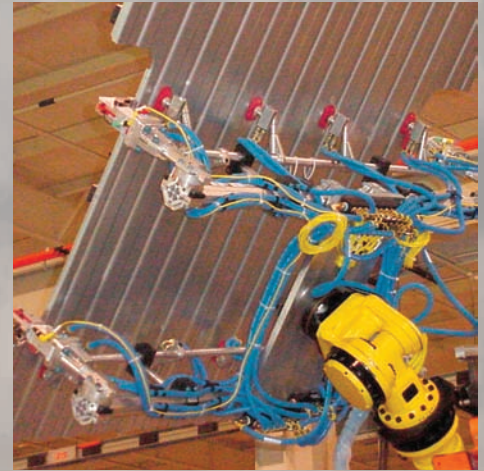

Precision Fit - No component slip octagonal boom structure provides increased stiffness and resistance to radial twisting during robot movement.

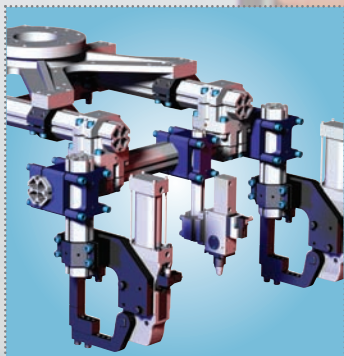

BODYBUILDER™ ROBOTIC END EFFECTORS

Ideal for robot-to-robot interaction, mechanical gripper holding, and body shop applications.

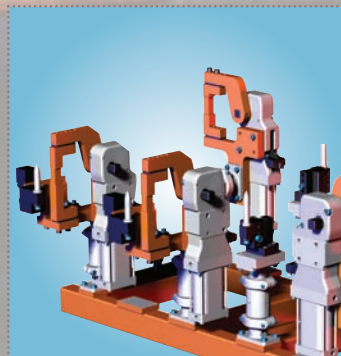

SPIDERGRIP™ MODULAR GEOMETRIC TOOLING

Ideal for robot-to-robot interaction, mechanical gripper holding, and body shop applications.



CARBON FIBER WORLD TOOL

Ideal for press load and unload, vacuum holding, and plastic injection applications.

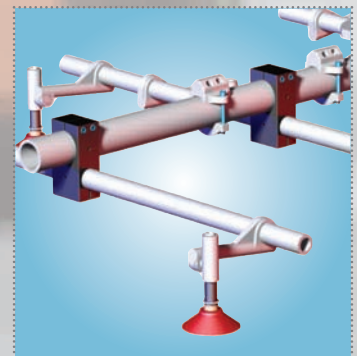

ROUND TOOLING SYSTEMS

Ideal for pick and place operations as well as press room, glass and materials handling applications.

END EFFECTOR COMPONENTS FOR THE TRANSPORTATION INDUSTRY

COMPREHENSIVE STANDARD PRODUCT OFFERING

- **Vacuum Products:** DE-STA-CO offers several families and sizes of vacuum cups for different surfaces, contours and applications. Auto-Release Venturi (ARV) cup mounts provide quick part release while requiring only one air line and one valve.
- **Pneumatic Modular Grippers:** There are two styles of modular grippers, the GR1 Modular Gripper and the GR84 Enclosed Mini Gripper. GR1 has a toggle-locking mechanism while the GR84's locking mechanism is protected from contaminants. They are excellent for gripping and transporting panels within very short cycle times.
- **Pneumatic Pivot Units:** Pivot units are offered in three different styles, medium duty, heavy duty and super duty. Each style is available in different sizes, depending on application requirements. Pivot units can be front, back, or side mounted so it can be used as a tip, dump, or rotate unit.
- **Pneumatic Weld Slide Units:** These are offered in three different sizes with four standard strokes for each size. Weld slides feature sealed, self-lubricating bearing systems which are easy to repair and maintain.

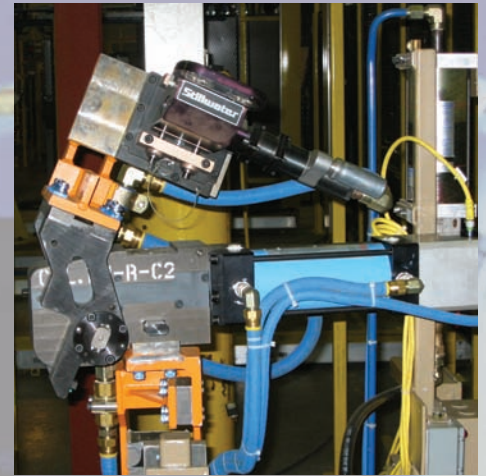

GR100 Medium Duty Pivot Unit

can be mounted vertically or horizontally as shown above. It uses a cylinder system which controls actuation while adding motion control.



VACUUM PRODUCTS

Ideal for pick and place operations as well as press room, glass and materials handling applications.



MODULAR GRIPPERS

Ideal for gripping, placing, removing and transporting parts in sheet metal applications.

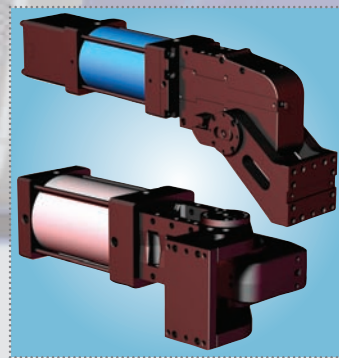

CLAMPS & PIVOTS

Ideal for clamping, holding, and positioning sheet metal in welding and body shop applications.

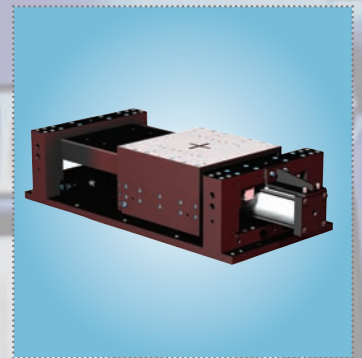

PNEUMATIC WELD SLIDES

Ideal for welding and body shop transfer applications.

PNEUMATIC & HYDRAULIC CLAMPS FOR THE TRANSPORTATION INDUSTRY

PNEUMATIC CLAMPS

- **Protected design:** Enclosed assembly reduces maintenance by retaining lubrication and protecting moving parts.
- **Flexible performance:** Clamping force can be maintained even when removed from air supply.
- **Extreme abilities:** High temperature models can withstand continuous exposure to 500° and short exposure to 700°.
- **Efficient size:** High clamping forces are provided in a compact, space-efficient design.



847-S



817-S-MR



9500 SERIES



CUSTOM PNEUMATIC CLAMP

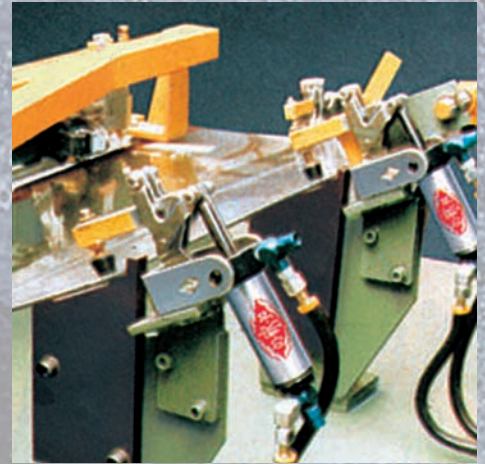

Light-duty clamps used to hold a panel into place on a fixture.

HYDRAULIC CLAMPS

- **System flexibility:** MRO interchange provides the ability to upgrade and interchange with other brands.
- **Highly adaptable:** Products feature multiple mounting and plumbing options.
- **Durable design:** Advanced seal and wiper technology resists contamination and leaks, while corrosion-resistant metal surfaces increase product life.
- **Improved productivity:** Setup times are significantly reduced through the ability to clamp an entire fixture from one location.



HYDRAULIC POWER SWING CLAMPS

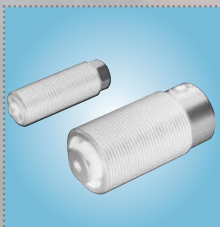

THREADED CYLINDERS



POWER UNITS



SPRING ADVANCE WORK SUPPORTS

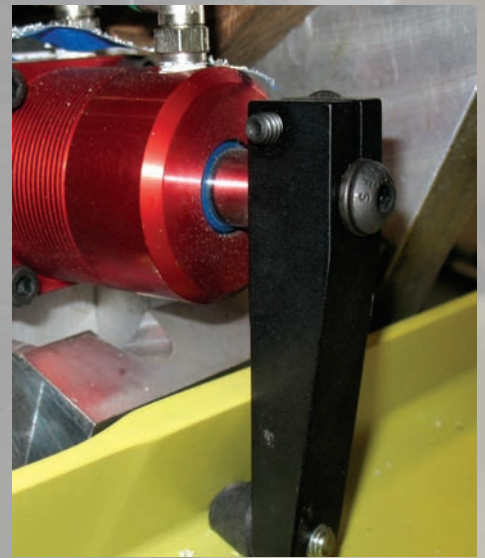

Our hydraulic clamps are ideal for the machining of engine parts.

MANUAL CLAMPS FOR THE TRANSPORTATION INDUSTRY

VERTICAL CLAMPS

- **Durable construction:** High performance achieved through torsion-protected, hardened bushings, stainless steel rivets and zinc plating.
- **Safe design:** Oil-resistant, ergonomically-shaped DE-STA-CO handle grip increases operational safety.
- **Advanced design:** DE-STA-CO® Toggle Lock Plus integrates a release lever that eliminates the potential for unintentional opening and closing.
- Bar openings range from 80° to 140°.
- Holding capacity ranges from 200 lbs. to 1,400 lbs.



202-U, 207-U, 210-U



207-UR, 210-UR
DE-STA-CO® TOGGLE
LOCK PLUS



2002-U, 2007-U,
2010-U



2002-UR, 2007-UR,
2010-UR DE-STA-CO®
TOGGLE LOCK PLUS

Model no.	Holding Capacity ▲ [N / lbf.]	Overall Height [mm / in.]	Height Under Bar [mm / in.]	Overall Length [mm / in.]
202-U	800 / 200	106.9 / 4.21	23.9 / 0.94	69.3 / 2.73
207-U	1,700 / 375	175.0 / 6.89	31.8 / 1.25	93.5 / 3.68
210-U	2,800 / 600	207.0 / 8.15	42.8 / 1.67	140.7 / 5.54
207-UR	1,700 / 375	175.3 / 6.90	31.8 / 1.25	116.3 / 4.58
210-UR	2,800 / 600	207.0 / 8.15	40.7 / 1.68	170.7 / 6.72
2002-U	2,800 / 600	120.1 / 4.73	24.3 / 0.95	83.6 / 3.29
2007-U	4,500 / 1,000	183.1 / 7.21	31.6 / 1.25	122.1 / 4.81
2010-U	6,200 / 1,400	228.6 / 9.00	43.3 / 1.70	154.7 / 6.09
2002-UR	2,800 / 600	120.1 / 4.73	24.3 / 0.95	105.9 / 4.17
2007-UR	4,500 / 1,000	183.1 / 7.21	31.6 / 1.25	150.9 / 5.94
2010-UR	6,200 / 1,400	228.6 / 9.00	43.8 / 1.70	184.9 / 7.28

Our manual vertical clamps offer excellent clamping capacity in a compact package.

HORIZONTAL CLAMPS

- **Durable construction:** High performance achieved through stainless steel rivets and zinc plating.
- **Safe design:** Oil-resistant, vinyl-dipped DE-STA-CO handle grip increases operational safety.
- **Advanced design:** DE-STA-CO® Toggle Lock Plus integrates a release lever that eliminates the potential for unintentional opening and closing.
- Bar openings range from 70° to 90°.
- Holding capacity ranges from 60 lbs. to 1,680 lbs.

The compact design and excellent clamping force of our horizontal clamps make them ideal for a wide variety of transportation applications.



225-U, 235-U



225-UR, 235-UR
DE-STA-CO® TOGGLE
LOCK PLUS



2017-U

Model no.	Holding Capacity ▲ [N / lbf.]	Overall Height [mm / in.]	Height Under Bar [mm / in.]	Overall Length [mm / in.]
225-U	2,200 / 500	46.7 / 1.84	33.5 / 1.32	170.2 / 6.70
235-U	3,200 / 750	64.8 / 2.55	44.5 / 1.75	276.1 / 10.87
225-UR	2,200 / 500	48.8 / 1.92	33.5 / 1.32	181.4 / 7.14
235-UR	3,200 / 750	64.8 / 2.55	44.5 / 1.75	276.1 / 10.87
2013-U	1,310 / 295	32.3 / 1.27	19.0 / 0.75	149.3 / 5.88
2017-U	2,490 / 560	176.5 / 6.95	24.9 / 0.98	218.9 / 8.62
2027-U	3,740 / 840	55.9 / 2.20	33.5 / 1.32	251.0 / 9.88
2037-U	7,470 / 1,680	69.9 / 2.75	41.2 / 1.62	339.1 / 13.35

MANUAL CLAMPS FOR THE TRANSPORTATION INDUSTRY

STRAIGHT-LINE ACTION CLAMPS

- **Flexible performance:** Models lock in both the extended and retracted positions.
- **Durable construction:** High performance achieved through stainless steel rivets and zinc plating.
- **Safe design:** Oil-resistant, ergonomically-shaped DE-STA-CO handle grip increases operational safety.
- **Adaptable solution:** Plunger contains internal threading.
- Holding capacity ranges from 300 lbs. to 800 lbs.

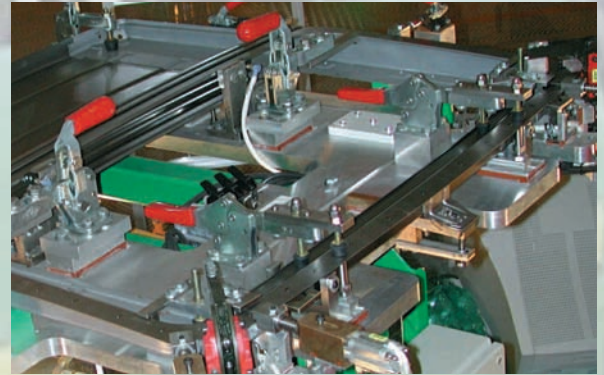

Used in part location, our **straight-line action clamps** improve efficiency in machining and assembly applications.



605

607

610

Model no.	Holding Capacity ↔ [N / lbf.]	Overall Height [mm / in.]	Overall Length [mm / in.]
605	1,335 / 300	87.4 / 3.44	139.2 / 5.48
607	3,560 / 800	90.4 / 3.56	152.7 / 6.01
610	3,560 / 800	115.6 / 4.55	170.7 / 6.72

VARIABLE STROKE STRAIGHT-LINE ACTION CLAMPS

- **Flexible operation:** To meet applications' specific needs, both one-hand and two-hand operation models are available.
- **Multiple mounting options:** Models include options for foot base mounting, flange mounting and through hole mounting.
- **High flexibility:** Versatile clamps use interchangeable plungers for one or two-hand operation.
- Holding capacity ranges from 300 lbs. to 2,000 lbs.

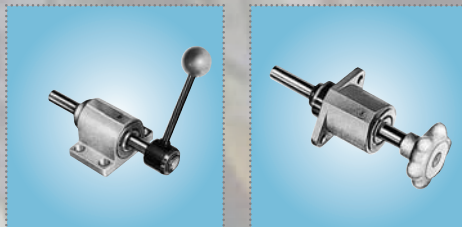

FO

FL

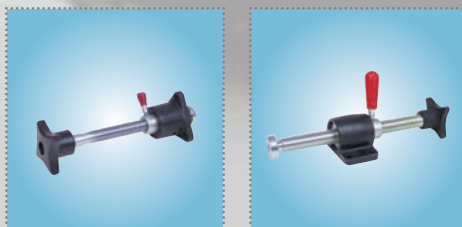

FRF

FRL

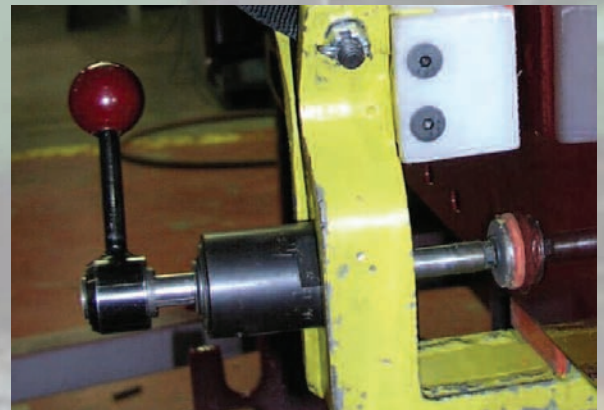

Variable straight-line action clamps can be used to accurately position straight-line motion when parts have variable movement.

Model no.	Holding Capacity ↔ [N / lbf.]	Overall Height [mm / in.]	Overall Length [mm / in.]
605	1,335 / 300	87.4 / 3.44	139.2 / 5.48
607	3,560 / 800	90.4 / 3.56	152.7 / 6.01
610	3,560 / 800	115.6 / 4.55	170.7 / 6.72

MANUAL CLAMPS FOR THE TRANSPORTATION INDUSTRY

SQUEEZE ACTION PLIER CLAMPS

- **Increased flexibility:** High quality clamping forces are provided where permanent, stationary clamping of workpieces is not possible.
- **Durable construction:** Heavy strength, drop-forged steel is used to guarantee maximum performance and reliability.
- **Safe design:** Oil-resistant, vinyl-dipped DE-STA-CO handle grip increases operational safety.
- **Efficient operation:** Some models feature a two-way trigger release for fast and easy opening of clamp.
- Holding capacity ranges from 100 lbs. to 1,200 lbs.

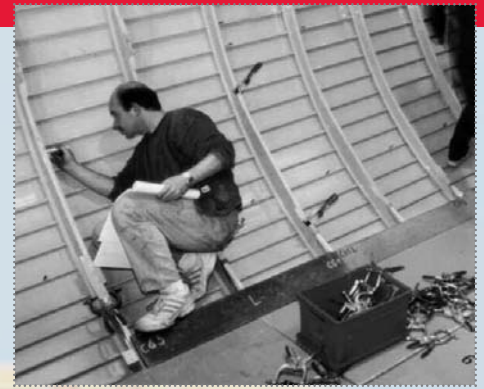

Our easy-to-use **squeeze action plier clamps** are ideal for holding laminations of materials during riveting.



431

462

480

Model no.	Holding Capacity ↕ [N / lbf.]	Overall Length [mm / in.]
431	450 / 100	154.7 / 6.90
462	3,200 / 700	215.9 / 8.50
480	5,340 / 1,200	33.3 / 1.31

LATCH CLAMPS

- **Advanced design:** DE-STA-CO® Toggle Lock Plus integrates a thumb control lever to eliminate the potential for unintentional opening.
- **Durable construction:** High performance achieved through stainless steel rivets and zinc plating.
- **Safe design:** Oil-resistant, ergonomically-shaped DE-STA-CO handle grip increases operational safety.
- **Complete solution:** U-shaped hooks and latch plates are included with clamps.
- Holding capacity ranges from 360 lbs. to 2,000 lbs.

Our **latch clamps** are ideal for use during the assembly process.

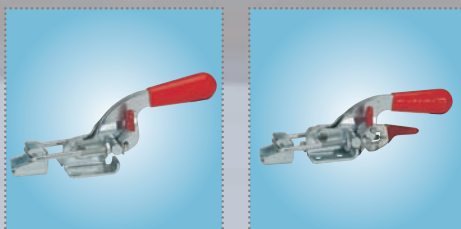

331, 341

331-R, 341-R
DE-STA-CO® TOGGLE
LOCK PLUS

Model no.	Holding Capacity ↕ [N / lbf.]	Overall Height [mm / in.]	Height Under Bar [mm / in.]	Overall Length [mm / in.]
331	3,200 / 700	50.3 / 1.97	16.8 / 0.66	153.9 / 6.06
341	7,000 / 2,000	37.4 / 2.89	23.9 / 0.94	208.3 / 8.20
331-R	3,200 / 700	52.8 / 2.08	16.8 / 0.66	153.9 / 6.06
341-R	7,000 / 2,000	73.4 / 2.89	23.9 / 0.94	208.3 / 8.20

MODULAR AUTOMATION SOLUTIONS



TO RECEIVE THE HIGHEST POSSIBLE BENEFIT from an automation system, you need a solution tailored to your specific applications. DE-STA-CO approaches automation from a modular perspective, using our unique DIRECTCONNECT™ technology to allow for quick and easy mounting of components without adaptor plates. This method allows for virtually unlimited motions using up to four axes. By offering a limitless variety of configurations, DE-STA-CO has an automation system perfectly suited for your operations.

UNIQUE ADVANTAGES YOUR LEAN BENEFITS!

- Easy to Design • • Reduce and Simplify System Design Time
- DIRECTCONNECT™ Technology • • Improve Repeatability and Accuracy
- Easy to Order • • Simple Steps to Walk You Through Your Finished Design
- Comprehensive Digital Documentation • • Reference at Your Fingertips
- Superior Customer Support • • No Hang-ups! Speak One-on-one with an Engineer for Immediate Answers
- Infinite Configurations • • Electric and Pneumatic Product Combinations Offer an Unlimited Number of Motions
- On-Time Delivery • • No Delays to Your Project
- Work with Experts • • FREE! Use Us as an Expert Consultant to Your Team!

DIRECTCONNECT™

DIRECTCONNECT™

DE-STA-CO's unique DIRECTCONNECT™ system eliminates the need for adaptor plates, providing easy and efficient modular automation connectivity. By using standardized mounting patterns, DIRECTCONNECT™ provides the flexibility necessary to meet any automation requirement.

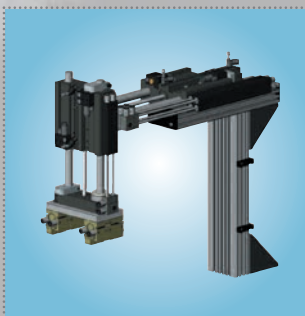

Dual Gripper Two Axis Box Motion

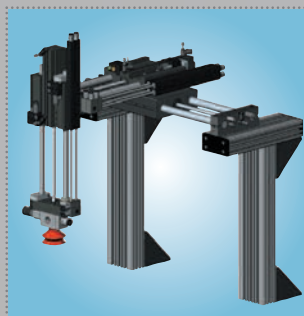

Three Axis Box Motion Vacuum Pick and Place

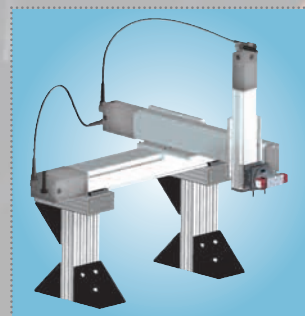

Servo "X", "Y", and "Z" with Pneumatic Rotary and Gripper



DCM-L1 Light Duty Conveyor Series

OTHER AUTOMATION COMPONENTS FOR THE TRANSPORTATION INDUSTRY

NEW

CONVEYORS

- **Flexible options:** Assembled and component-based systems offer lower prices and shorter delivery times.
- **Comprehensive solutions:** We offer numerous conveyor system options for light, medium and heavy duty applications, as well as modular conveying systems.
- **Intelligent control electronics:** Regulate the belt speed independent of load.
- **Fast and easy belt change:** belts can be changed in less than eight minutes for the center drive, and only three minutes for the end drive.

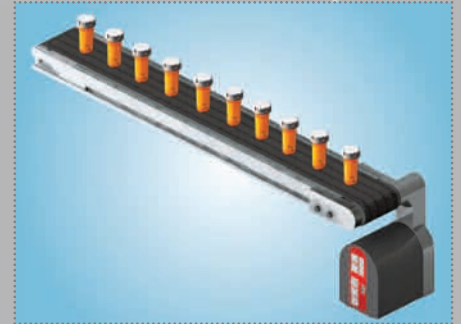

LIGHT DUTY CONVEYORS

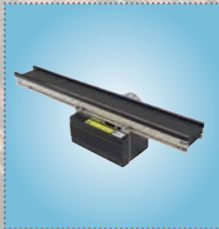

MEDIUM DUTY CONVEYORS



HEAVY DUTY CONVEYORS

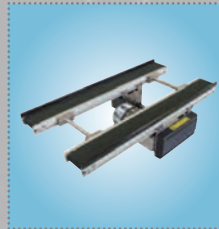

DUAL BELT CONVEYORS



PALLETIZED SYSTEMS



ACCESSORIES

DE-STA-CO'S COMPREHENSIVE LINE of automation components provides a wide range of solutions for transportation manufacturing and assembly applications. Our limitless variety of configurations ensures that we can provide a solution to meet your specific needs.



SLIDES

Ideal for the assembly and manufacture of components, our slides quickly and easily mount together without adaptor plates, and allow you to create an almost unlimited range of multi-axis pick and place devices.



ROBOTIC TOOLCHANGERS

Our robotic toolchangers provide a quick and easy way to change end effector tooling to accommodate many different styles of parts on the same robot. These toolchangers also offer accurate positional repeatability and withstand moment loads of up to 7,000 in./lbs. – even in harsh environments.

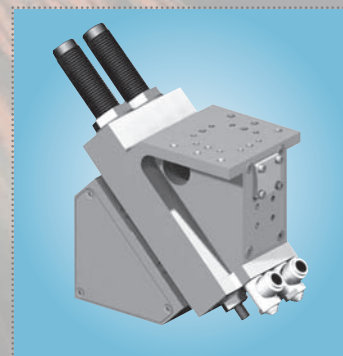

ROTARY ACTUATORS

Zero-backlash, preloaded ball bearings and slip fit dowel pins ensure high precision in our rotary actuators, which are ideal for machine load and unload applications. Our actuators can be supplied with grippers and sensors premounted or with blank mounting surfaces for customer supplied tooling.

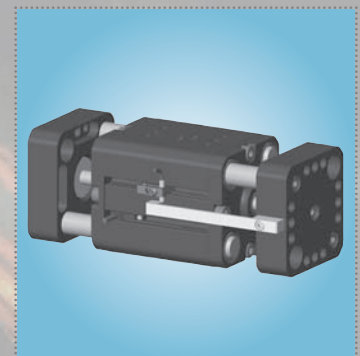

GRIPPERS

DE-STA-CO offers a comprehensive line of grippers, many of which support long finger lengths and excel in the handling and transfer of large and heavy parts. Our patented DIRECT-CONNECT™ technology eliminates the need for adaptor plates.

A TRUE GLOBAL PRESENCE

Through a constant commitment to the Team DE-STA-CO philosophy, we draw from our worldwide pool of information and resources to offer the highest levels of service to each of our customers, regardless of geographic location. Our status as a truly global company empowers us to improve the global competitiveness of your operations. Whatever your automation or workholding need, Team DE-STA-CO has the best possible solution.



NORTH AMERICA

DE-STA-CO Headquarters
Auburn Hills, Michigan

Tel: 1.248.836.6700
Marketing: marketing@destaco.com

DE-STA-CO Workholding Products
Auburn Hills, Michigan

Tel: 1.888.DESTACO
Customer Service: cs-workholding@destaco.com

DE-STA-CO Automation Products
Monroe, Connecticut

Tel: 1.888.DESTACO
Customer Service: cs-automation@destaco.com

DE-STA-CO Automotive Products
Charlevoix, Michigan

Tel: 1.888.DESTACO
Customer Service: cs-automotive@destaco.com

SOUTH AMERICA

DE-STA-CO Brazil

Tel: 0800-124070
Customer Service: samerica@destaco.com

INDIA

DE-STA-CO (Dover India, Ltd.)

Tel: +91 80 22211961, 22275533
Customer Service: info@destaco.com

EUROPE

DE-STA-CO Europe (Germany)

Tel: +49-6171-705-0
Customer Service: europe@destaco.com

DE-STA-CO Automation Products (France)

Tel: +33-1-3996-5000
Customer Service: france@destaco.com

DE-STA-CO UK

Tel: +44-1902-797980
Customer Service: uk@destaco.com

DE-STA-CO Spain

Tel: +34-936361680
Customer Service: spain@destaco.com

DE-STA-CO Benelux

Tel: +31-297285332
Customer Service: benelux@destaco.com

ASIA

DE-STA-CO Thailand

Tel: +66-2-326-0812
Customer Service: info@destaco.com

DE-STA-CO Shanghai Co., Ltd.

Tel: +86-21-6081-2888
Customer Service: china@destaco.com

Please visit
www.destaco.com
for a distributor near you.



Positioning our customers for productivity.