

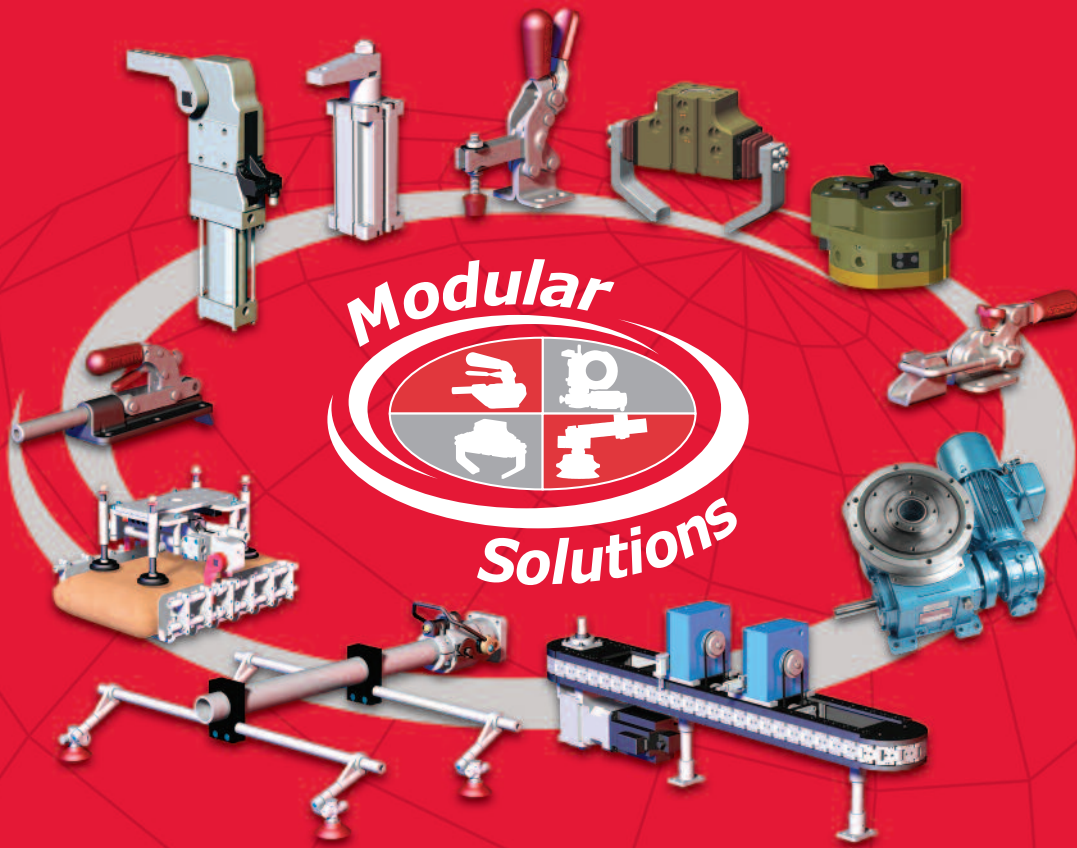

DE-STA-CO MODULAR SOLUTIONS



- PROJECT MANAGEMENT**
- CLAMPING/GRIPPING**
- CONVEYORS**
- TOOL CHANGERS**
- END EFFECTORS**
- INDEXING**
- AUTOMATION**
- SIMULATION**
- CUSTOM DESIGN**

www.destaco.com

Precisely positioning our customers for productivity.

Look for
our exclusive

DIRECTCONNECT
technology.

DE-STA-CO Modular Solutions

Today's manufacturing challenges are tougher than ever. Regardless of your application, DE-STA-CO offers workholding and automation solutions to meet your needs.

OUR PRODUCTS ARE IDEAL FOR A WIDE RANGE OF INDUSTRIES AND MANUFACTURING PROCESSES.

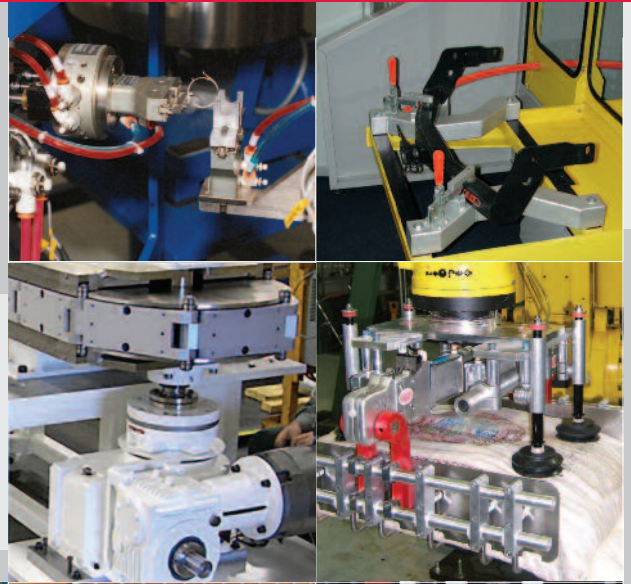

DE-STA-CO Provides Complete single source Solutions with a comprehensive offering of products to help customers **Hold, Grip, Locate, Place,** and **Index** their parts with precision



Workholding

Vertical Handle



Horizontal Handle

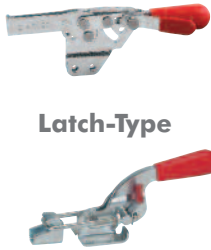

Straight-Line Action



Variable-Stroke Straight-Line Action

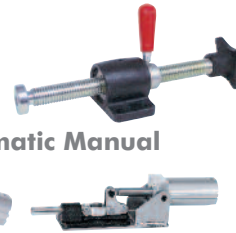

Plier-Type



Latch-Type



Pneumatic Manual



Carver



Automation Power Clamps



Vacuum Products



Tool Changers and Adaptors

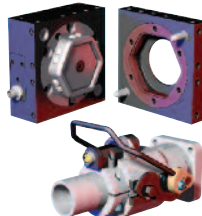

Modular Gripping Products

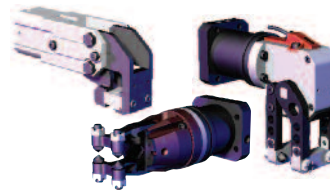

Pin Clamps and Packages

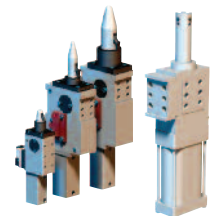

BodyBuilder End Effectors

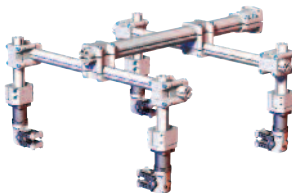

SpiderGrip Geometric End Effectors

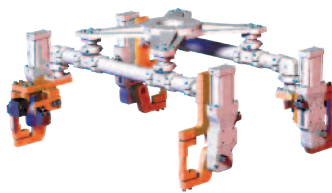

Round Tooling Components

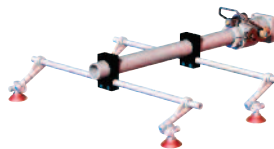

Customized Solutions



Automation
Robohand FERGUSON
CAMCO

E-Gripper®
Electric Gripper



Parallel and Angular Grippers

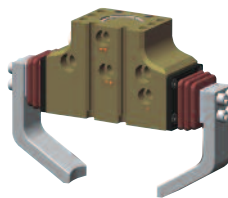

Rotary Actuators

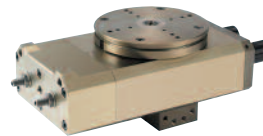

Slides and Thrusters



Index Drives



Ring Index Drives

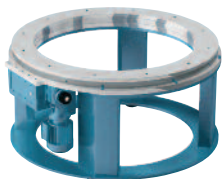

Part Handlers



IM-pAC AC Drives



Precision Link Conveyors

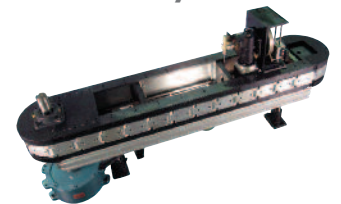

Body Builder

Bodybuilder™ End Effector Systems

Designed to maximize productivity, both before and after installation.

The flexibility of the system allows modifications to the end effector in minutes, greatly reducing start up time to launch.

Ready-to-assemble mounts and accessories eliminate drilling and welding at assembly.

Octagonal structures available in four sizes: 30mm, 45mm, 60mm, and 90mm.

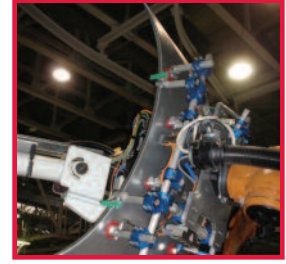
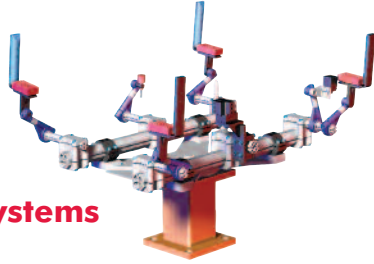

All BodyBuilder™ extruded octagonal booms and modular components are available for download in all 3D formats from www.destaco.com.

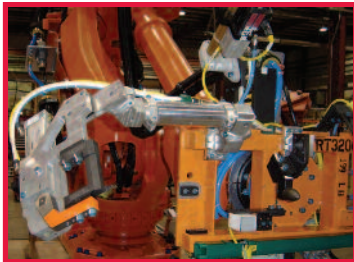

SpiderGrip Geometric End Effector Systems

Modular Components for Quick Configurations and Accuracy for Geo Tool Solutions

SpiderGrip offers a standard cost effective solution by making it easy for each component to be replaced individually in the robotic cell, dramatically reducing production downtime and eliminating the need for a backup end-effector.



PATENT PENDING

The lightweight collar and cross-key assembly is the cornerstone of SpiderGrip's modularity. The durable assembly serves as the vital connection between the components.

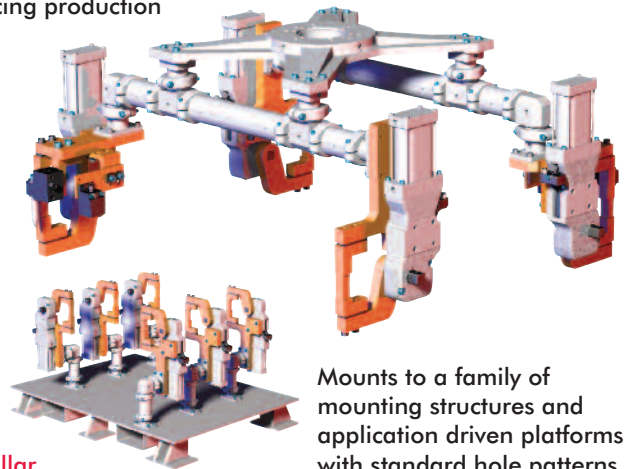

Mounts to a family of mounting structures and application driven platforms with standard hole patterns.

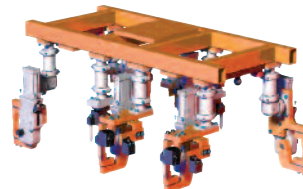

Round Tooling Systems

- Offers standard finger clamps for high volume, low cost, lightweight solutions.
- Part holding devices, such as grippers offer fast open/close cycle times and the best power to weight ratios.
- Other part holding devices include shovels and vacuum cups.
- Ideal for pick-and-place part handling, manual manipulating, and packaging/palletizing.
- All tooling components are constructed of lightweight aluminum and can be re-used for future applications.
- Automatic air and electric connection
- Easy connection and adjustment

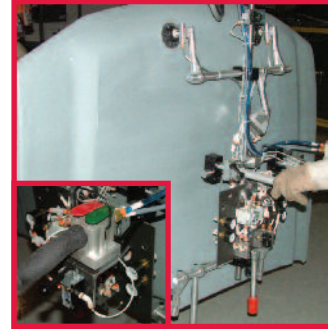
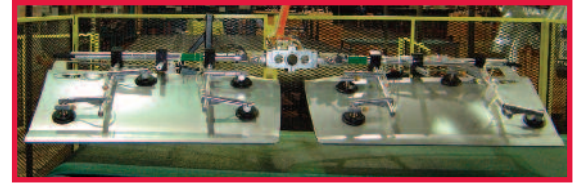
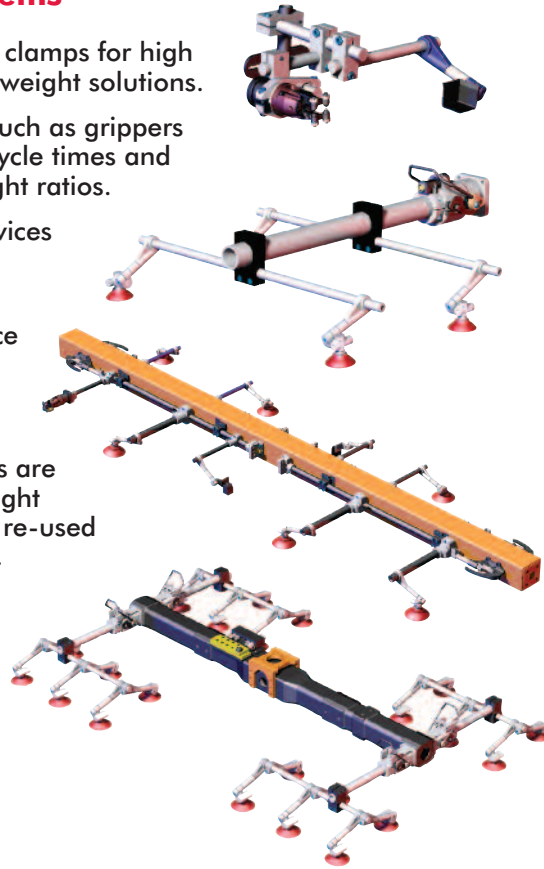

Carbon Fiber Main Booms

- Low Density, Reduced Weight
- High Stiffness, Low Deflection and Torsion

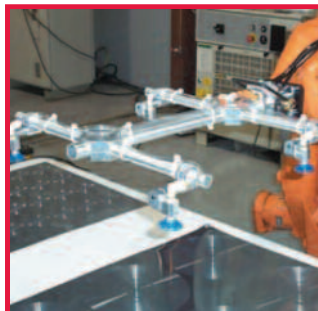

Ideal for small part handling, injection press unloading, pick-and-place applications, and unusual shaped objects.

Fully Customizable

Allows for unlimited configuration possibilities utilizing vacuum cups, sprue nippers, grippers, or other tooling.

Flexible Mounting

Systems allow for both cantilever end and mid-frame mounting for interfacing with the robot.

Manual or Fully Automatic Tool Changer

Permanently mount your tooling to the robot or choose from either manual or automatic tool changer. Optional quick disconnect air ports provide simple connect/disconnect for air power between various end effectors.

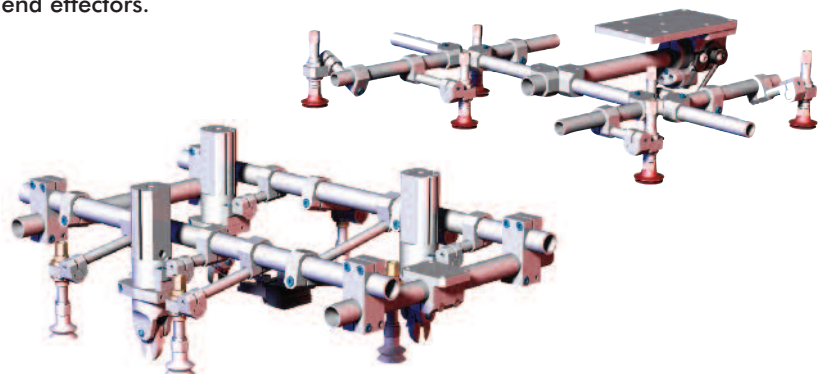

Solution Application Samples

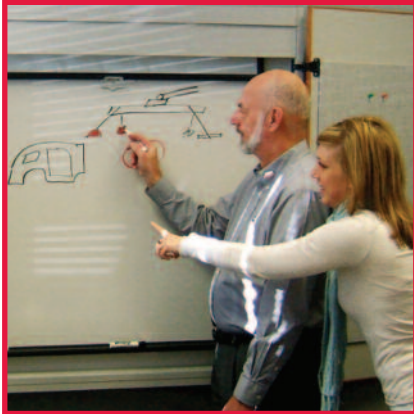

DE-STA-CO's design team works with customers to find the best solutions for their needs



Stove top stamping end of arm tooling using DE-STA-CO Vacuum Products and Round Tooling with Manual Tool Change

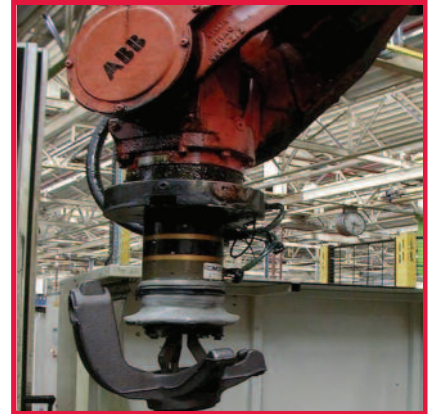

End of arm casting pick & place tool using a DE-STA-CO 3-Jaw gripper

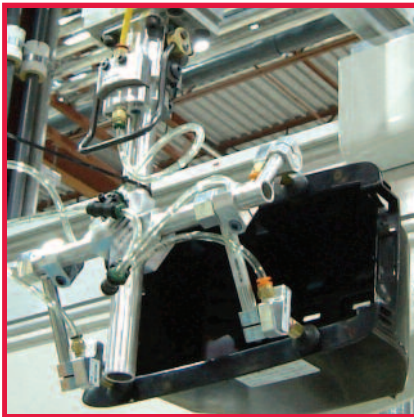

Unloading a plastic injection mold using DE-STA-CO Vacuum Products and Round Tooling

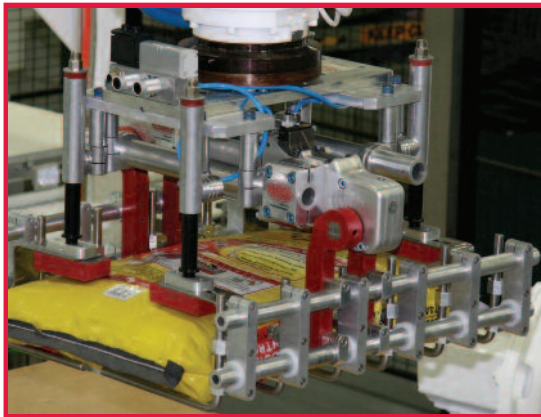

End of line bag palletizing using a DE-STA-CO DBG Series Bag Gripper

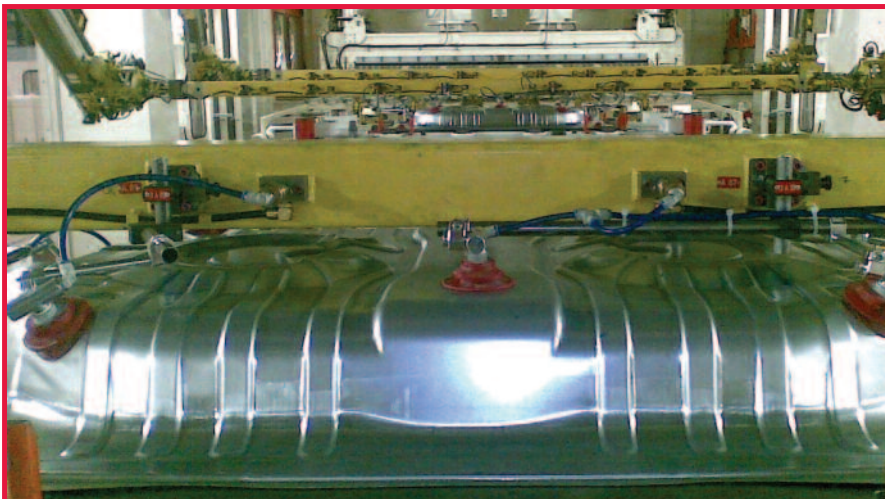
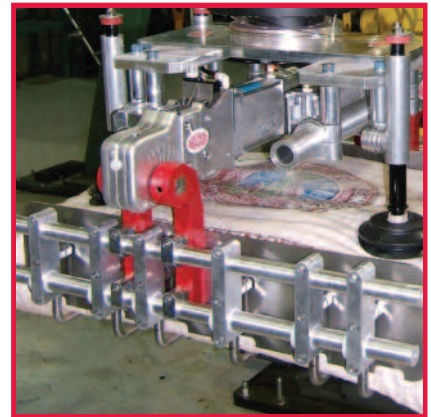

Automotive stamping end of arm tooling using DE-STA-CO Vacuum and Crossbar Transfer Press Tooling with Manual Tool Changers

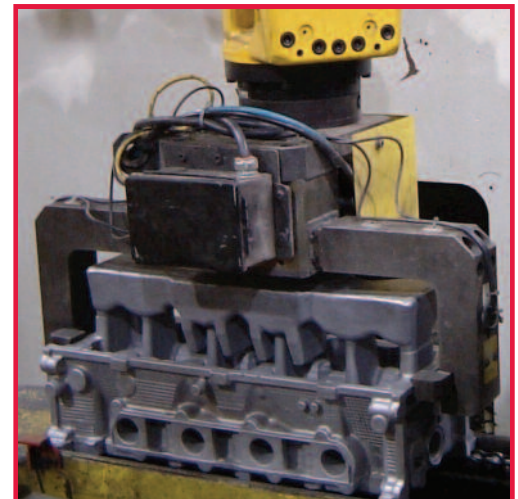

Engine Block end of arm tool using a DE-STA-CO Parallel Gripper

Solution Application Samples



Automotive stamping end of arm tooling using DE-STA-CO Vacuum and World Tool with Manual Tool Changers



Lower idle stand for press toom transfer using DE-STA-CO Indexers, Vacuum Products and Round framing



End of Arm Tool using DE-STA-CO Parallel Grippers to pick & place steel tubing and brake rotors

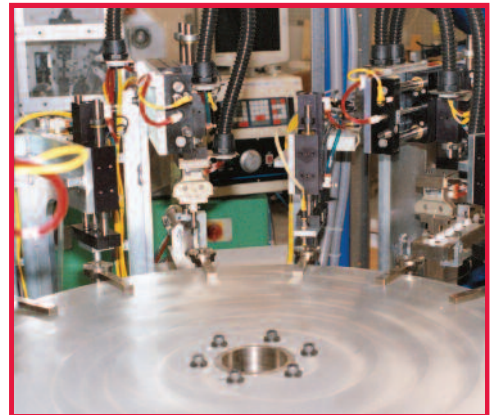

Indexing and pick and place application using Robohand parallel grippers and slides

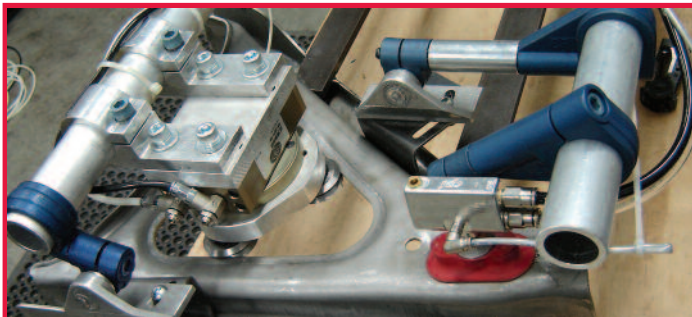

Pick and place application with round tooling and vacuum products



"Below-The-Hook" manual lift assist wheel rim tool using DE-STA-CO Round Tooling and 3-Jaw Grippers



A DOVER COMPANY

PRECISELY POSITIONING OUR CUSTOMERS FOR PRODUCTIVITY.

Workholding

Automation

- Widest variety of workholding products
- High durability and reliability
- Flexible solutions for all applications
- Custom products for unique requirements

- Broad range of engineered automation products
- Complementary products for modular integration
- Unmatched accuracy, reliability and performance
- Unparalleled global sales, service and engineering support

DE-STA-CO GLOBAL LOCATIONS

NORTH AMERICA

DE-STA-CO Headquarters
 Auburn Hills, Michigan
 Tel: 1.248.836.6700
 Toll Free: 1.888.DESTACO
 Marketing: marketing@destaco.com
 Customer Service: customerservice@destaco.com

Charlevoix, Michigan
 Tel: 1.888.DESTACO
 Customer Service: customerservice@destaco.com

Wheeling, Illinois
 Tel: 1.800.645.5207
 Customer Service: camco@destaco.com

Red Wing, MN (Central Research Laboratories)
 Tel: 651.385.2142
 Customer Service: sales@centres.com

SOUTH AMERICA

Brazil
 Tel: 0800-124070
 Customer Service: samerica@destaco.com

ASIA

Thailand
 Tel: +66-2-326-0812
 Customer Service: info@destaco.com

China
 Tel: +86-21-6081-2888
 Customer Service: china@destaco.com

India
 Tel: +91-80-41123421-426
 Customer Service: india@destaco.com

EUROPE

Germany
 Tel: +49-6171-705-0
 Customer Service: europe@destaco.com

France
 Tel: +33-1-3996-5000
 Customer Service: france@destaco.com

UK
 Tel: +44-1902-797980
 Customer Service: uk@destaco.com

Spain
 Tel: +34-936361680
 Customer Service: spain@destaco.com

Netherlands
 Tel: +31-297285332
 Customer Service: benelux@destaco.com



A DOVER COMPANY

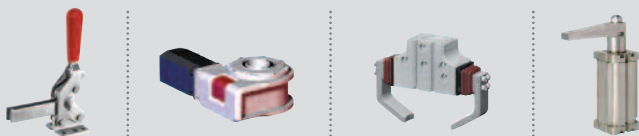

Precisely positioning our customers for productivity.

© Copyright, 2010 DE-STA-CO.

All rights with regards to logos, layout, photos and text, including all artwork, rest with DE-STA-CO.

All photomechanical or other reproductions can only be made with our expressed permission.

1025 Doris Road
 Auburn Hills, MI 48326
 Fax: (248) 836-6740
 Technical Support E-mail:
tech-automotive@destaco.com
www.destaco.com